Chapter 10 Water Table Control



Issued April 2001

The U.S. Department of Agriculture (USDA) prohibits discrimination in all its programs and activities on the basis of race, color, national origin, sex, religion, age, disability, political beliefs, sexual orientation, or marital or family status. (Not all prohibited bases apply to all programs.) Persons with disabilities who require alternative means for communication of program information (Braille, large print, audiotape, etc.) should contact USDA's TARGET Center at (202) 720-2600 (voice and TDD).

To file a complaint of discrimination, write USDA, Director, Office of Civil Rights, Room 326W, Whitten Building, 14th and Independence Avenue, SW, Washington, DC 20250-9410 or call (202) 720-5964 (voice and TDD). USDA is an equal opportunity provider and employer.

Acknowledgments

National Engineering Handbook Part 624, Chapter 10, Water Table Control, was prepared by **Ken Twitty** (retired) and **John Rice** (retired), drainage engineers, Natural Resources Conservation Service (NRCS), Fort Worth, Texas, and Lincoln, Nebraska respectively. It was prepared using as a foundation the publication Agricultural Water Table Management "A Guide for Eastern North Carolina," May 1986, which was a joint effort of the USDA Soil Conservation Service, USDA Agriculture Research Service (ARS), the North Carolina Agriculture Extension Service and North Carolina Agricultural Research Service.

Leadership and coordination was provided by **Ronald L. Marlow**, national water management engineer, NRCS Conservation Engineering Division, Washington, DC, and **Richard D. Wenberg**, national drainage engineer, NRCS (retired).

Principal reviewers outside NRCS were:

James E. Ayars, agricultural engineer, USDA-ARS, Pacific West Area, Fresno, California

Robert O. Evans, assistant professor and extension specialist, Biological and Agriculture Engineering Department, North Carolina State University, Raleigh, North Carolina

Norman R. Fausey, soil scientist-research leader, USDA-ARS, Midwest Area, Columbus, Ohio

James L. Fouss, agricultural engineer, USDA-ARS, Baton Rouge, Louisiana

Forrest T. Izuno, associate professor, agricultural engineering, University of Florida, EREC, Belle Glade, Florida

The principal reviewers within NRCS were:

Terry Carlson, assistant state conservation engineer, Bismarck, North Dakota

Chuck Caruso, engineering specialist, Albuquerque, New Mexico

Harry J. Gibson, state conservation engineer, Raleigh, North Carolina

David Lamm, state conservation engineer, Somerset, New Jersey

Don Pitts, water management engineer, Gainesville, Florida

Patrick H. Willey, wetlands/drainage engineer, National Water and Climate Center, Portland, Oregon

Nelton Salch, irrigation engineer, Fort Worth, Texas (retired)

Paul Rodrique, wetland hydrologist, Wetlands Science Institute, Oxford, Mississippi

Rodney White, drainage engineer, Fort Worth, Texas (retired)

Jesse T. Wilson, state conservation engineer, Gainesville, Florida

Donald Woodward, national hydrologist, Washington, DC

Editing and publication production assistance were provided by **Suzi Self**, **Mary Mattinson**, and **Wendy Pierce**, NRCS National Production Services, Fort Worth, Texas.

Chapter 10 Water Table Control

Contents:	624.1000	Introduction	10-1
		(a) Definitions	10-1
		(b) Scope	10-1
		(c) Purpose	10-1
	624.1001	Planning	10-3
		(a) General site requirements	10-3
		(b) Considerations	10-3
		(c) Management plan	10-3
	624.1002	Requirements for water table control	10-4
		(a) Soil conditions	10-4
		(b) Site conditions	10-9
		(c) Water supply	10-10
	624.1003	Hydraulic conductivity	10-12
		(a) Spatial variability	10-12
		(b) Rate of conductivity for design	10-14
		(c) Performing hydraulic conductivity tests	10-17
		(d) Estimating hydraulic conductivities	10-25
		(e) Determine the depth to the impermeable layer	10-27
	624.1004	Design	10-27
		(a) Farm planning and system layout	10-27
		(b) Root zone	10-33
		(c) Estimating water table elevation and drainage coefficients	10-34
		(d) Design criteria for water table control	10-39
		(e) Estimating tubing and ditch spacings	10-41
		(f) Placement of drains and filter requirements	10-55
		(g) Seepage losses	10-56
		(h) Fine tuning the design	10-68
		(i) Economic evaluation of system components	10-74
	624.1005	Designing water control structures	10-82
		(a) Flashboard riser design	10-82

624.1006	Management	10-83
	(a) Computer aided management	10-83
	(b) Record keeping	10-83
	(c) Observation wells	10-84
	(d) Calibration	10-86
	(e) Influence of weather conditions	10-87
624.1007	Water quality considerations of water table control	10-89
	(a) Water quality impacts	10-89
	(b) Management guidelines for water quality protection	10-89
	(c) Management guidelines for production	10-90
	(d) Example guidelines	10-91
	(e) Special considerations	10-91
624.1008	References	10-93

Tables	Table 10-1a	Effective radii for various size drain tubes	10-43
	Table 10-1b	Effective radii for open ditches and drains with gravel envelopes	10-43
	Table 10-2	Comparison of estimated drain spacing for subirrigation for example 10-6	10-73
	Table 10-3	Description and estimated cost of major components used in economic evaluation of water management alternatives	10-75
	Table 10-4	Variable costs used in economic evaluation of water management options	10-76
	Table 10-5	Predicted net return for subsurface drainage/ subirrigation on poorly drained soil planted to continuous corn	10-81
	Table 10-6	Water table management guidelines to promote water quality for a 2-year rotation of corn-wheat-soybeans	10-92

Figures		
Figure 10-1	Flow direction and water table position in response to different water management alternatives	10-2
Figure 10-2	Determining site feasibility for water table control using soil redoximorphic features	10-4
Figure 10-3	Location of the artificial seasonal low water table	10-5
Figure 10-4	A typical watershed subdivided by major drainage channels	10-6
Figure 10-5	Excellent combination of soil horizons for manipulating a water table	10-7
Figure 10-6	Soil profiles that require careful consideration for water table control	10-7
Figure 10-7	Good combination of soil horizons for water table management	10-8
Figure 10-8	A careful analysis of soil permeability is required before water table management systems are considered	10-8
Figure 10-9	Good soil profile for water table control	10-8
Figure 10-10	Careful consideration for water table control required	10-8
Figure 10-11	Uneven moisture distribution which occurs with subirrigation when the surface is not uniform	10-11
Figure 10-12	A field that requires few hydraulic conductivity tests	10-13
Figure 10-13	A site that requires a variable concentration of readings based on complexity	10-13
Figure 10-14	Using geometric mean to calculate the hydraulic conductivity value to use for design	10-14
Figure 10-15	Delineating the field into design units based on conductivity groupings	10-15
Figure 10-16	Delineating the field into design units based on conductivity groupings	10-15
Figure 10-17	Delineating the field into design units based on conductivity groupings	10-16

Figure 10-18	Symbols for auger-hole method of measuring hydraulic conductivity	10-17
Figure 10-19	Auger-hole method of measuring hydraulic conductivity	10-19
Figure 10-20	Hydraulic conductivity—auger-hole method using the Ernst Formula	10-21
Figure 10-21	Equipment for auger-hole method of measuring hydraulic conductivity	10-23
Figure 10-22	Estimating the overall conductivity using estimated permeabilities from the Soil Interpretation Record	10-26
Figure 10-23	Determining depth to impermeable layer (a) when the impermeable layer is abrupt, (b) when the impermeable layer is difficult to recognize, and (c) when the impermeable layer is too deep to find with a hand auger	10-27
Figure 10-24	General farm layout	10-28
Figure 10-25	Initial survey to determine general layout of the farm	10-29
Figure 10-26	Contour intervals determined and flagged in field	10-30
Figure 10-27	Farm plan based on topographic survey	10-31
Figure 10-28	Typical rooting depths for crops in humid areas	10-33
Figure 10-29	Percent moisture extraction from the soil by various parts of a plant's root zone	10-33
Figure 10-30	Determining the apex of the drainage curve for the ellipse equation	10-34
Figure 10-31	Estimating drainable porosity from drawdown curves for 11 benchmark soils	10-35
Figure 10-32	Determining the allowable sag of the water table midway between drains or ditches and the tolerable water table elevation above drains or in ditches during subirrigation	10-37
Figure 10-33	Estimating water table elevations midway between drains or ditches	10-38

Figure 10-34	Plastic tubing drainage chart	10-40
Figure 10-35	Situation where it is not practical to satisfy minimum recommended cover and grade	10-41
Figure 10-36	Estimating ditch or tubing spacing for drainage only using the ellipse equation	10-42
Figure 10-37	Estimating ditch or tubing spacing for subirrigation using the ellipse equation	10-42
Figure 10-38	Use of ellipse equation to estimate ditch or tubing spacing for controlled drainage	10-43
Figure 10-39	Determining the ditch spacing needed for controlled drainage	10-45
Figure 10-40	Determining the ditch spacing for subirrigation	10-46
Figure 10-41	Determining the tubing spacing for controlled drainage	10-48
Figure 10-42	Determining the tubing spacing for subirrigation	10-51
Figure 10-43	Placement of tubing or ditches within the soil profile	10-55
Figure 10-44	Water table profile for seepage from a subirrigated field to a drainage ditch	10-56
Figure 10-45	Water table profile for seepage from a subirrigated field	10-57
Figure 10-46	Seepage from a subirrigated field to an adjacent non-irrigated field that has water table drawdown because of evapotranspiration	10-59
Figure 10-47	Vertical seepage to a ground water aquifer during subirrigation	10-59
Figure 10-48	Schematic of a 128 hectare (316 acre) subirrigation system showing boundary conditions for calculating lateral seepage losses	10-60
Figure 10-49	Seepage along boundary A-B	10-61
Figure 10-50	Schematic of water table position along the north boundary	10-63

Figure 10-51	Schematic of water table and seepage along the east boundary	10-64
Figure 10-52	Seepage under the road along boundary A-D	10-66
Figure 10-53	Determining the tubing spacing for subirrigation using the design drainage rate method	10-70
Figure 10-54	Locating observation wells, and construction of the most popular type of well and float	10-85
Figure 10-55	Construction and location of well and float	10-85
Figure 10-56	Observation and calibration methods for open systems, parallel ditches or tile systems which outlet directly into ditches	10-86
Figure 10-57	Observation and calibration systems for closed drain systems	10-86
Figure 10-58	Water table control during subirrigation	10-87
Figure 10-59	Water table control during drainage	10-87
Figure 10-60	Sample water table management plan	10-88

Examples	Example 10-1	Ditch spacing for controlled drainage	10-44
	Example 10-2	Ditch spacing necessary to provide subirrigation	10-46
	Example 10-3	Tubing spacing for controlled drainage	10-48
	Example 10-4	Drain tubing for subirrigation	10-51
	Example 10-5	Seepage loss on subirrigation water table control system	10-60
	Example 10-6	Design drainage rate method	10-71
	Example 10-7	Economic evaluation	10-74

624.1000 Introduction

Water table control is installed to improve soil environment for vegetative growth, improve water quality, regulate or manage water for irrigation and drainage, make more effective use of rainfall, reduce the demand for water for irrigation, reduce runoff of fresh-water to saline nursery areas, and facilitate leaching of saline and alkali soil.

Chapter 10 is intended as a guide for the evaluation of potential sites and the design, installation, and management of water table control in humid areas. The information presented encompasses sound research and judgments based on short-term observations and experience.

(a) Definitions

The following terms describe the various aspects of a water table control system illustrated in figure 10-1.

Controlled drainage—Regulation of the water table by means of pumps, control dams, check drains, or a combination of these, for maintaining the water table at a depth favorable to crop growth.

Subirrigation—Application of irrigation water below the ground surface by raising the water table to within or near the root zone.

Subsurface drainage—Removal of excess water from the land by water movement within the soil (below the land surface) to underground conduit or open ditches.

Surface drainage—The diversion or orderly removal of excess water from the surface of land by means of improved natural or constructed channels, supplemented when necessary by shaping and grading of land surfaces to such channels.

Water table control—Removal of excess water (surface and subsurface), through controlled drainage, with the provision to regulate the water table depth within desired parameters for irrigation.

Water table management—The operation of water conveyance facilities such that the water table is either adequately lowered below the root zone during wet periods (drainage), maintained (controlled drainage), or raised during dry periods (subirrigation) to maintain the water table between allowable or desired upper and lower bounds. The best management can be achieved with water table control where the needs of the plant root environment and the water quality goals can be met during all occasions.

(b) Scope

The information in this chapter applies only to those areas that have a natural water table or potential for induced water table. Emphasis is placed on the design, installation, and management of a water table control plan in humid areas.

(c) Purpose

Chapter 10 provides guidance and criteria to plan, design, install, and manage a water table control system that improves or sustains water quality, conserves water, and increases the potential to produce food and fiber efficiently.

Figure 10-1 Flow direction and water table position in response to different water management alternatives

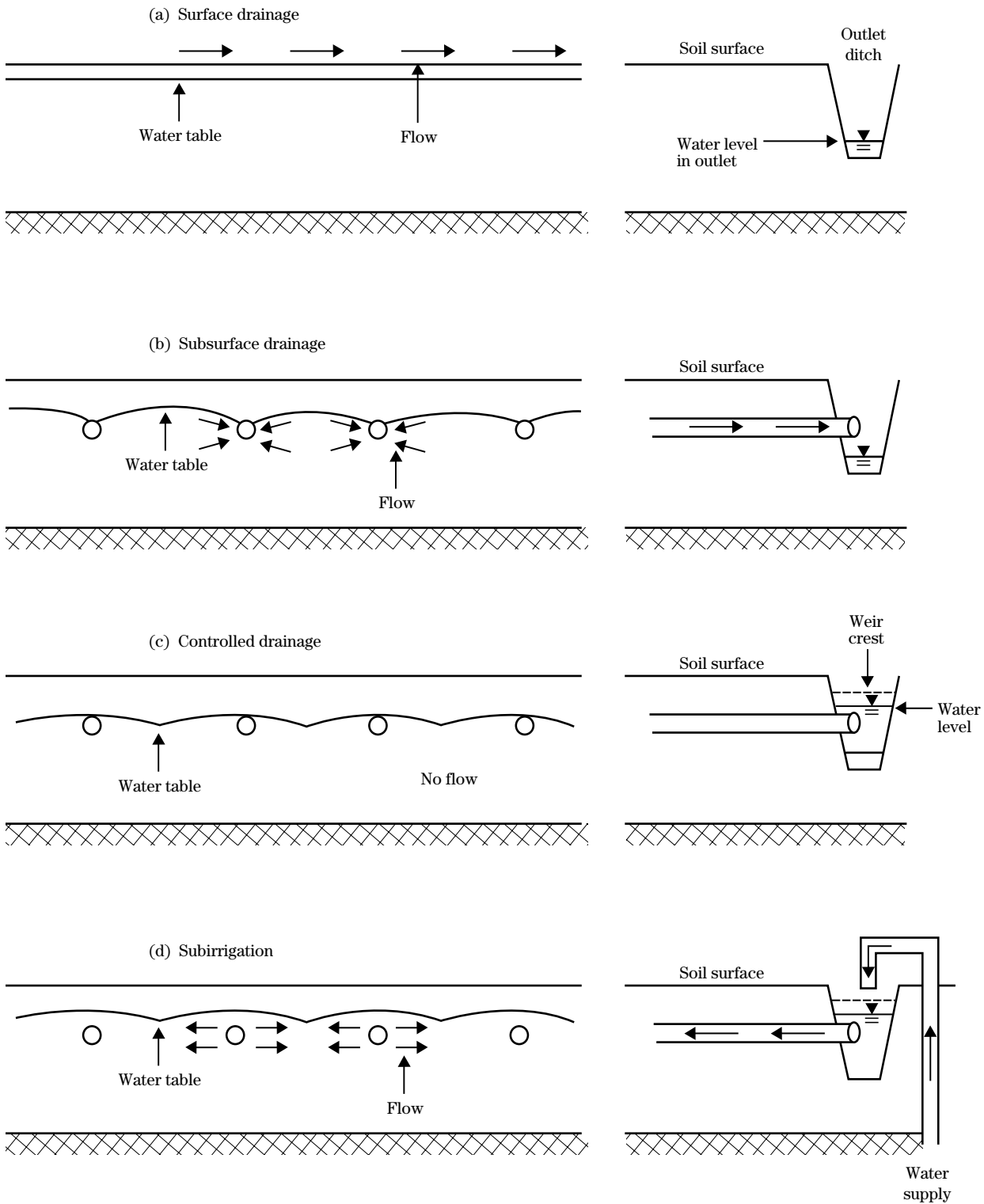

624.1001 Planning

(a) General site requirements

The following conditions are necessary for establishing water table control. Proceed with the planning process if the potential site meets these conditions.

- A natural high water table exists, or can be induced.
- The topography is relatively smooth, uniform, and flat to gently sloping.
- Subsurface conditions are such that a water table can be maintained without excessive water loss.
- Soil depth and permeability permit effective operation of the system.
- The site has an adequate drainage outlet, or one can be provided.
- An adequate water supply is available.
- Saline or sodic soil conditions can be maintained at an acceptable level for crop production.
- Suitable soil water chemistry so that, if subsurface drains are installed, iron ochre will not become a serious long-term problem.

(b) Considerations

Several factors should be considered in planning.

- Ensure actions will not violate Natural Resources Conservation Service wetland policy.
- Evaluate the entire area for possible impacts.
- Survey the area affected including surrounding land, and divide the area into manageable zones.
- Evaluate possible drainage outlets for adequacy. The outlets must be stable and have capacity to pass drainage flows without damaging property.
- Evaluate existing drainage facilities for feasibility of use in a new system.
- Confirm the suitability of the quantity and quality of water supply.
- Plan locations of surface field ditches, laterals, and subsurface drains.

- Select the location of the water control structures so that the water table can be managed between planned elevations. Vertical interval of structures should be less than 0.5 foot for very sandy soils and should rarely exceed 1.0 foot.
- Evaluate the type of subsurface drains, structures, pumps, plus other controls and devices to be included in alternative plans.
- Consider the need and desirability of land grading or smoothing.
- Perform an economic analysis to determine the feasibility of the alternative plans.

(c) Management plan

The water management plan must provide guidance on:

- A system to monitor and observe the water table.
- Upper and lower bounds of the water table for all conditions.
- A recordkeeping system of observation well readings, water added, and observed crop responses.

The plan must also include procedures to calibrate water table levels between control points and critical areas of the field for ease of management. It should allow for a performance review of the system during the year using the operator's records. To assess the performance, all findings should be studied immediately after the harvest. The management plan for the coming year should then be changed as necessary.

624.1002 Requirements for water table control

(a) Soil conditions

Soils at the site of the proposed system should be assessed for suitability. A critical part of the planning process is to evaluate the potential site's capability for a natural or induced high water table. This section is intended to acquaint the user with certain site conditions that should exist for an area to be considered suitable.

(1) Natural seasonal high water table

The presence of a natural seasonal high water table near the soil surface indicates the potential to maintain a water table at an elevation suitable for subirrigation during dry periods. The same soil properties and site conditions that enable a soil to exhibit a seasonal high water table near the surface also enable an induced water table to be sustained during dry periods.

Where the seasonal high water table is naturally more than 30 inches below the soil surface, the soil is well drained. As such, excessive seepage makes it increasingly difficult to develop and maintain a water table close enough to the root zone to supply the crop water needs. Considering the landscape position of these soils, installation of water table control is generally not recommended (fig. 10-2).

Figure 10-2 Determining site feasibility for water table control using soil redoximorphic features *

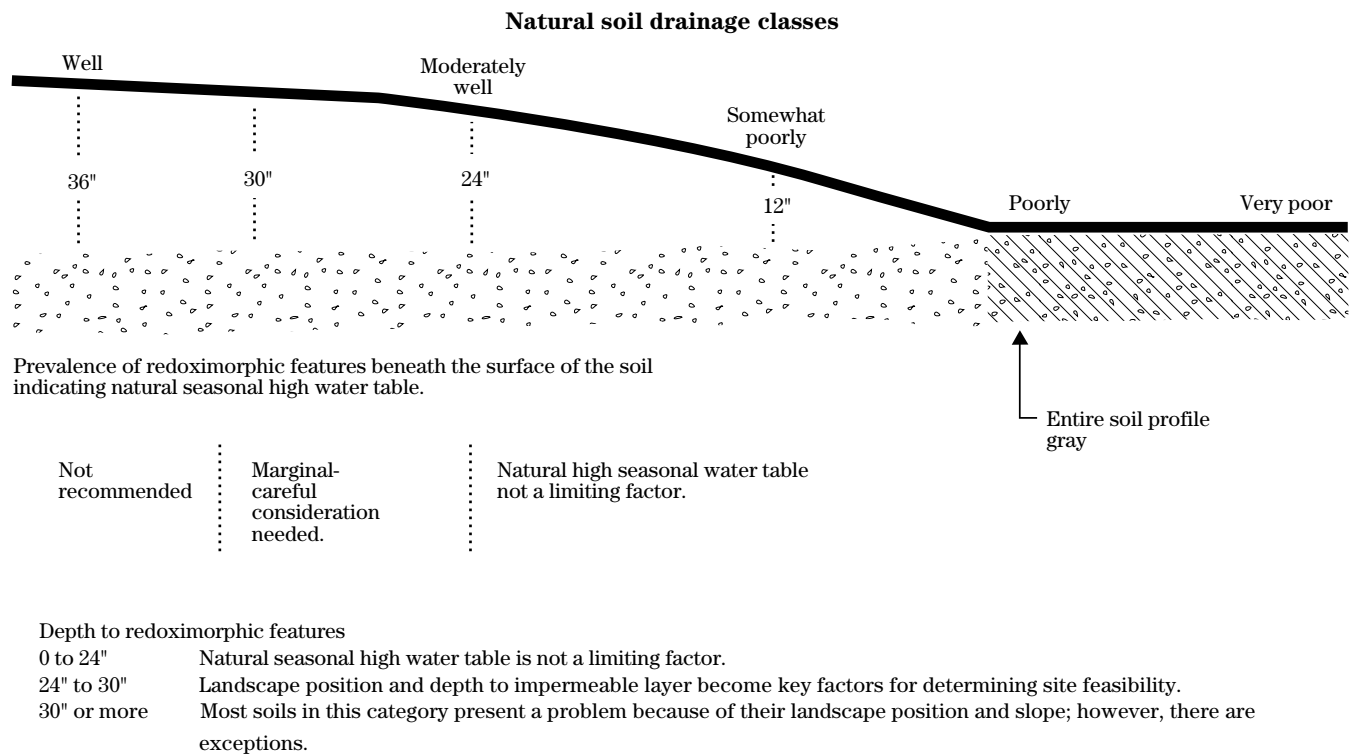

* Location of natural seasonal high water table is the only consideration in using this figure.

The occurrence of a natural seasonal high water table can be determined by interpreting color changes in the soil caused by reduction/oxidation of iron and manganese. These redoximorphic features can appear as spots of dull gray surrounded by bright yellow or red. They are in areas of the soil that remain saturated for prolonged periods. As the soil becomes more poorly drained, the features become more prominent and eventually the entire soil profile becomes gray. Figure 10-2 illustrates a soil catena with respect to redoximorphic features.

Seepage is a concern when designing subirrigation on any soil, but as the depth to the natural seasonal high water table increases, this concern intensifies. The amount of lateral and deep seepage must be calculated during the design to ensure the seepage losses are not prohibitive.

(2) Seasonal low water table

The depth to the seasonal low water table becomes a concern in many watersheds that are extensively drained. In these watersheds the natural seasonal low water table depth may vary from a high of 1.5 feet to a summer low of more than 5 feet (fig. 10-3).

Extensive drainage poses a problem for subirrigation. Under these conditions the water table used for subirrigation must be raised from the artificial seasonal low water table. Excessive rates of lateral seepage can be a problem where the potential site is surrounded by deep drainage ditches or in areas of soils that have a deep seasonal low water table (fig. 10-4).

The depth to the artificial low seasonal water table must be taken into consideration during the design process. The depth can be measured by using observation wells during dry periods, or it can be approximated by using the depth of the drainage channels adjacent to the site.

Figure 10-3 Location of the artificial seasonal low water table

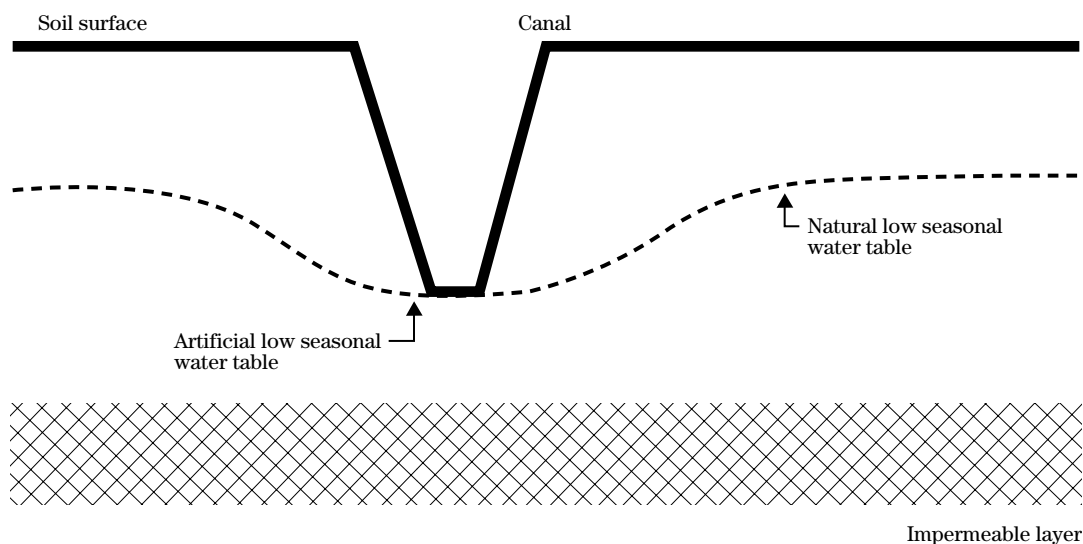
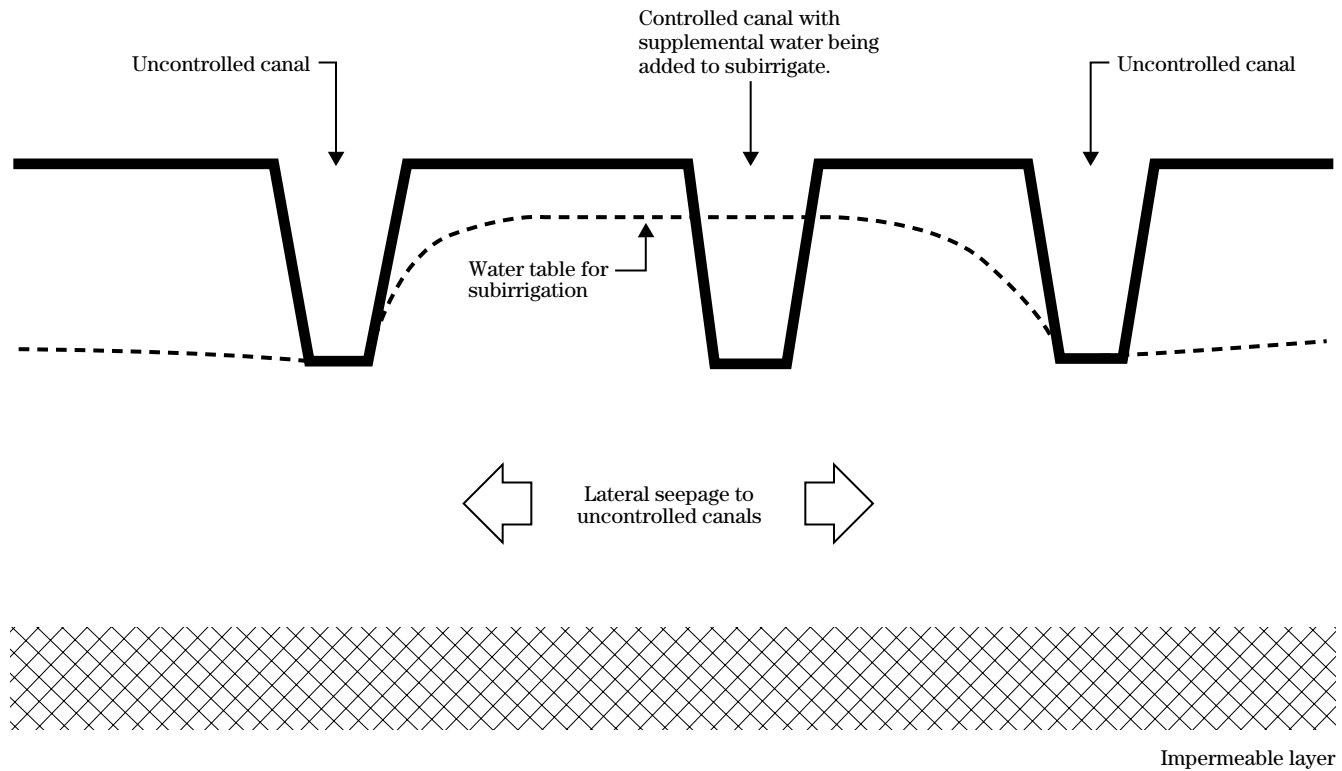

Figure 10-4 A typical watershed subdivided by major drainage channels*



* The depth to the artificial low seasonal water table becomes important when subirrigation must be built on the artificial low seasonal water table, rather than an impermeable layer. Excessive lateral seepage may result where the site is surrounded or bordered by extensive uncontrolled drainage systems.

(3) Soil profile

The permeability of each soil horizon within the soil profile must be considered when evaluating a site for water table control. In some cases these horizons vary significantly in permeability. The location and thickness of these horizons within the soil profile affect the suitability for water table control. A soil map provides some guidance during initial site evaluation, but considering the high investment costs for most systems, a detailed soil investigation is highly recommended.

Figure 10-5 Excellent combination of soil horizons for manipulating a water table

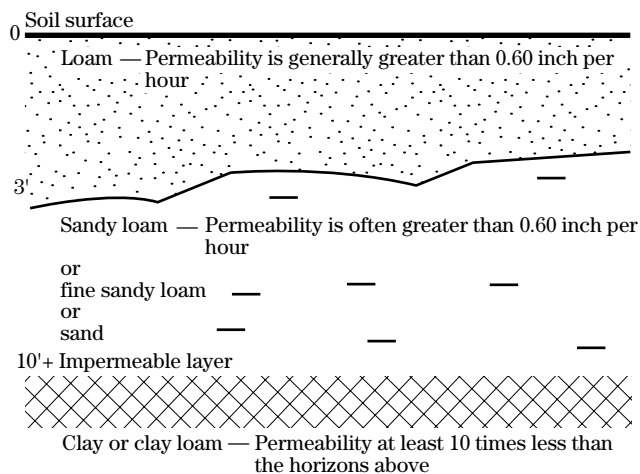

Component installation considerations:

Field ditches—Installed to a depth that would barely pierce the sandy horizon.

Tubing—Installed at or below the interface of the loam and sandy horizon if possible. Filter requirements should be determined.

Figures 10-5 through 10-10 show marginal and excellent soil profiles for water table control. These profiles represent a few situations that may occur. These illustrations reinforce the importance of making a detailed investigation of soil horizons when considering potential sites for water table control.

Figure 10-6 Soil profiles that require careful consideration for water table control

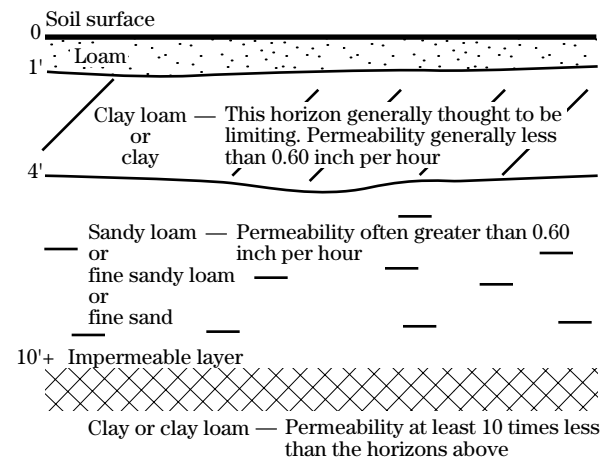

Component installation considerations:

Thickness and permeability of clayey horizon—If the clay loam extends to a depth of more than 5 feet, the water table is difficult to manage. If the clay loam is less than 3 feet deep, this soil responds quite well. Where the clay extends from 3 to 5 feet, response has been variable.

Tubing—Locate at or below interface of clayey and sandy horizons.

Field ditches—Installed to a depth that would pierce the sandy horizon.

Figure 10-7 Good combination of soil horizons for water table management

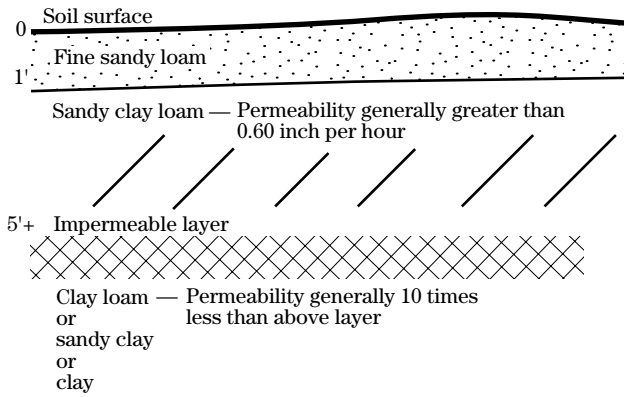

Component installation considerations:

Depth to impermeable layer—Becomes more limiting as the depth to the impermeable layer decreases.

Tubing—Determine need for filter.

Figure 10-8 A careful analysis of soil permeability is required before water table management systems are considered

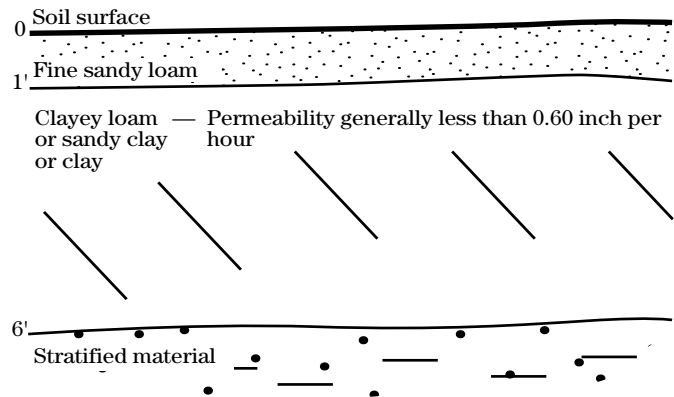

Component installation considerations:

Thickness and permeability of clayey horizon—If the clay horizon extends to a depth of more than 5 feet, the water table is difficult to manage. If it is less than 3 feet deep, this soil responds well if the stratified layer is permeable. If clay is between 3 and 5 feet deep, response is variable.

Figure 10-9 Good soil profile for water table control*

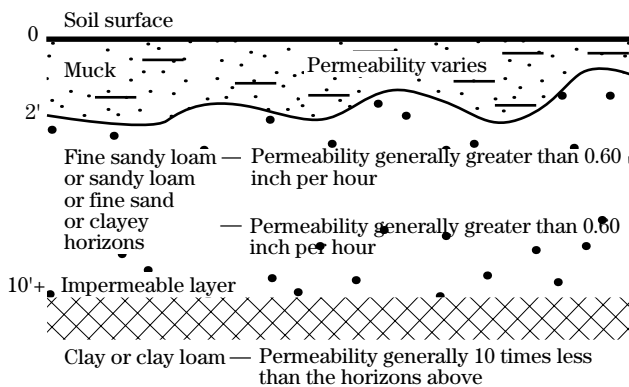

Component installation considerations:

Thickness and permeability of muck layer.

Wood debris.

Muck underlain by a clayey horizon is not as well suited to water table control as soils that have sandy horizons.

* This soil profile represents soil types that have a shallow organic layer at the surface. Where the organic layer is more than 2 feet thick, problems may arise with excessive wood debris and in some cases permeability.

Figure 10-10 Careful consideration for water table control required

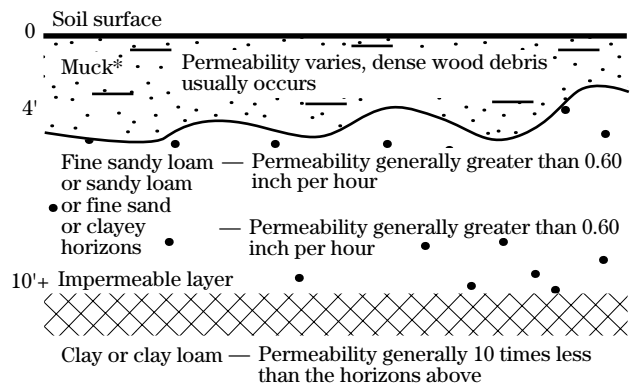

Component installation considerations:

Thickness and permeability of muck.

Wood debris.

Where the muck is underlain by a clayey horizon, this profile is generally not suited to water table control.

* The muck layer generally becomes the limiting factor where it is more than 2 feet thick. Wood debris usually becomes dense, and permeability varies.

(4) Soil permeability

The potential of any site for water table control is strongly influenced by the permeability of the soil. As the permeability becomes slower, the cost for installing water table control increases. A careful economic analysis is needed to justify installation.

A minimum soil permeability of 0.60 inch per hour is recommended for general planning. Where the soil has permeability of less than 0.60 inch per hour, economics may be the most limiting factor. Water table control in this soil may be economical if other costs are low, especially the water supply.

Hydraulic conductivity (permeability) is the most important soil property affecting the design of water table control. Conductivity values have been shown to be quite variable from field to field within the same soil series. For this reason the final design should be based on field measured conductivity. Methods of measuring hydraulic conductivity in the field are described in section 624.1003.

(5) Barrier

Soils must have a barrier at a reasonable depth to prevent excessive vertical seepage losses if water table control is to be considered. An impermeable layer or a permanent water table is needed within 10 to 25 feet of the soil surface.

The location of an impermeable layer within the soil profile must be determined if it is to be the barrier for sustaining a water table. The hydraulic conductivity of this layer must be measured or estimated from its texture.

The depth to a permanent water table must be determined when it is used as the barrier. Observation wells can be used, or an estimate can be made based on the depth of the deepest ditch.

(b) Site conditions

(1) Drainage outlets

Drainage is a primary consideration when evaluating the potential of any site for water table control. A drainage outlet must be available that has adequate capacity to remove surface and subsurface water within the required time. An outlet may be established by pumping or may be a gravity flow system, but it must be available before installation of water table control components.

(2) Existing drainage systems

Most areas considered for water table control generally have existing surface and subsurface water removal systems operated as uncontrolled drainage. However, as water levels are controlled, these systems may prove to be inadequate. When a landowner is contemplating establishing a water table control system, the existing drainage system must be evaluated in terms of how well it will function under a different management system.

(3) Water sources

An adequate, dependable source of water must be available for subirrigation. The location, quantity, and quality of the water source are key factors to consider.

The quantity of water needed for a subirrigation system varies depending upon the weather, crop, management, and rate of vertical and lateral seepage. For example, a water source must be capable of producing 7 gallons per minute per acre irrigated, given a maximum evapotranspiration rate of 0.25 inch per day and an irrigation efficiency of 70 percent. A water source of 700 gallons per minute for 100 acres would be a reasonable initial estimate of the water needed assuming no water is required for soil leaching, crop cooling, or other activity.

The costs of the water supply may be a significant factor. An economic evaluation is recommended to assure the subirrigation costs are feasible.

The quality of the water must be evaluated to determine suitability for the planned crop and soil before subirrigation is installed.

As a guideline for assessing a potential site, a source of water that has a concentration of salts exceeding 2,000 ppm is considered limited for use on most crops. If the water source fluctuates in salinity, irrigation should be discontinued when the salt concentration exceeds 2,000 ppm. Certain crops have a substantially lower threshold for salt concentrations in the irrigation water. If the decision is made to proceed with irrigation, extreme caution is suggested.

(4) Slope considerations

Soils that can support water table control are generally on landscape positions that rarely exhibit slopes steep enough to physically prohibit the proper management of a water table. In some cases these soils exhibit slopes considered excessive. As the slope increases, more control structures are required, which increases the costs. Therefore, the limiting factor with respect to slope is usually economics rather than physical slope conditions. The maximum slope that can be used when installing water table control is site specific.

Soils capable of supporting water table control seldom have surface slopes of more than 2 percent. Careful consideration is needed as the slope increases, normally seepage losses are greater, the cost increases, and soil erosion may become a problem. As the slope approaches 1 percent, the economic factors and erosion begin to inhibit the installation.

(5) Land grading and smoothing considerations

The amount of land grading or smoothing required to assure adequate surface drainage and to establish a uniform slope is normally sufficient for water table control. The costs of modifications and effects on the soil productive capacity are the limiting factors.

The relief of the landscape on a potential site is an important consideration. The area to be subirrigated must have adequate surface drainage and simultaneously provide a slope that allows uniform soil moisture for the crop. Use the landowner's experience and evaluate the land during several wet periods.

Another factor is the uniformity of the slope, which must be considered with respect to the relief of a potential site. If subirrigation is to provide uniform moisture conditions, an abrupt change of slope or significant change in elevation of the soil surface must not occur throughout the area being controlled as one zone.

Shallow rooted crops, such as lettuce, tolerate no more than a half foot variation in soil surface elevation throughout the area being managed as an irrigation zone, if optimal crop production is desired. Crops that have a deeper root system, such as corn, may tolerate greater variations. Water table variations exceeding 1 foot from the soil surface throughout the area being managed as a single zone may result in some degree of loss of annual crop productivity. This is dependent upon the climate, crop, and surface removal of runoff.

Perennial crops may adapt their root system to a surface condition that varies more than 1 foot within the zone, but the water table must be managed so that fluctuations are for short periods that can be tolerated by the crop without loss of production. When reducing the surface variation to within the most desired range is not practical, the water table must be managed to obtain the optimum benefit within the zone. The optimum water table level will be related to its depth below ground elevation within the zone that should not result in ridges being too dry or depressions too wet (fig. 10–11).

Soil productivity may limit a site for water table control when land smoothing or grading is performed. The site may be restricted by the depth of soil that can be removed to improve surface drainage and subirrigation. Field experience has demonstrated that some soils undergo a diminished capacity to produce high yields after extensive soil removal. Most disturbed soils can be restored to their original productive capacity within a year or two. However, in some cases where the topsoil has been completely removed, the productive capacity of the soil may need many years to partially restore or require the redistribution of the original topsoil to fully restore its productive capacity.

(c) Water supply

An important factor to consider with water table control is the water supply. The closer drain spacing normally needed for subirrigation is of little benefit if an adequate water supply is not available. Controlling drainage outflow may be beneficial although irrigation water is not available. The amount of water actually required for subirrigation and the benefit of either controlled drainage or subirrigation are functions of crop, soil, and local weather conditions.

(1) How much water is enough?

During peak water use periods, crops may require 0.25 inch per day or more. This corresponds to a water supply capacity of 4.7 gallons per minute per acre just to satisfy crop water needs. The design capacity normally recommended would be greater to account for irrigation losses, such as evaporation and seepage. Crop water needs can often be supplied at a capacity of less than the design capacity with proper management and minimum seepage. Rainfall is more effective if the water table is maintained slightly below the controlled drainage elevation because the soil will have greater capacity to store rainfall.

Plant available water stored in the soil as the water table falls from 18 to 36 inches, will range from about 0.5 inch up to more than 2 inches. This represents water available for plant use in addition to what is being added to the system. A limited water supply of 4.0 gallons per minute per acre added at 85 percent efficiency plus soil storage or effective rainfall of 1 inch could supply the crop need of 0.21 inch per day for up to a month. During prolonged dry periods, the water table cannot be maintained to meet evapotranspiration without an adequate water supply capacity. For this reason, the length and probability of dry periods for a given location must be considered. This can best be accomplished using long-term weather records and simulation with computer models, such as DRAINMOD.

Seepage in many soils may represent a significant water loss that must be replenished by the water supply. Seepage losses are very difficult to estimate and should be eliminated where possible. These losses may be vertical or lateral (horizontal).

Lateral seepage losses can be quite large. Smaller fields have proportionally greater lateral seepage losses as a result of a higher perimeter to area ratio. Lateral losses may be from uncontrolled drainage ditches or irrigation supply ditches that adjoin an unirrigated area. In these cases lateral seepage losses may consume up to 25 percent of the supply capacity. When subirrigation is installed in fields with old abandoned tile drains, significant seepage losses may result unless the lines are adequately controlled.

Lateral seepage losses can be minimized with good planning and layout. Whenever possible, supply canals should be located near the center of irrigated fields rather than along the side. Perimeter ditches and outlet canals should also be controlled with structures. Controlling the drainage rate can significantly reduce seepage to these ditches. The control level in the outlet ditch may be maintained somewhat lower than the irrigation ditch to provide some safety for drainage; however, a 6- to 12-inch gradient from the field to the outlet ditch is much more desirable than a 4- to 6-foot gradient which could occur if no control was practiced. Whenever possible, irrigated fields should be laid out in square blocks adjoining other irrigated fields. This minimizes the length of field boundary along which seepage can occur.

Figure 10-11 Uneven moisture distribution which occurs with subirrigation when the surface is not uniform

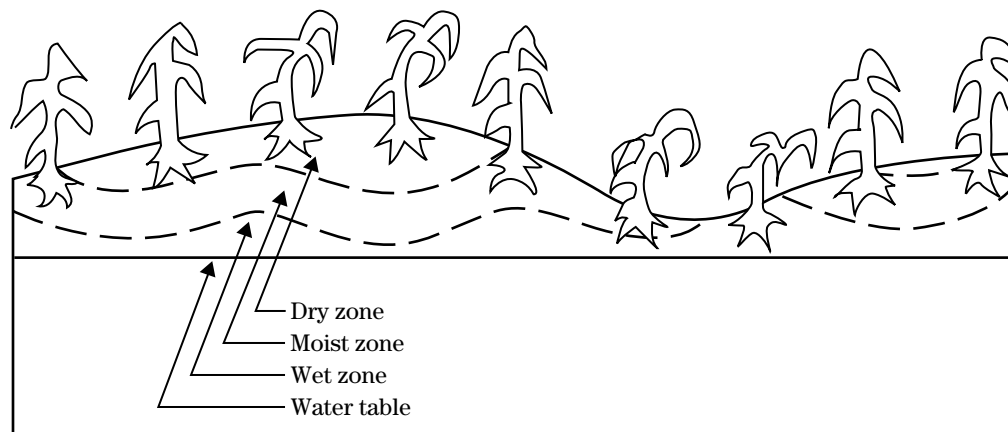

The additional water capacity needed to overcome the seepage loss should be estimated when this loss cannot be controlled. Methods to estimate seepage losses under steady state conditions are described in section 624.1004. To use these methods, the location and size of the seepage boundary, the hydraulic gradient along the boundary, and hydraulic conductivity through the boundary must be identified. Unfortunately, this is usually difficult. Several measurements may be required because the seepage zone is often composed of several layers of varying thickness and conductivity. When making these measurements is impossible or inconvenient, the water supply capacity may need to be increased 25 to 30 percent to replace possible seepage losses. The added cost of this additional supply often justifies the time and effort required to get a better estimate.

(2) Types of water supplies

When planning a subirrigation water supply, three factors should be considered: location, quantity, and quality. The water supply should be located close to the irrigated area to reduce conveyance losses, pumping cost, and investment in conveyance system. The major sources of irrigation water are reservoirs, streams, and wells. The source of water is unimportant provided sufficient water of good quality is available to meet the needs of the crop.

For further information on types of water supplies, water quality for irrigation, and pumping plants refer to Field Office Technical Guide, State Irrigation Guide, and local Extension Information.

624.1003 Hydraulic conductivity

The design of a water table control system must be based on site specific data. The designer should determine the number of hydraulic conductivity (permeability) tests needed and the location of each test within the boundaries of the site. This step helps the designer to ultimately select the value or values to be used in all calculations. The value must represent the capabilities of the field. Soil borings also provide the thickness and location of horizons, depth to impermeable layers, and other information needed to determine the final design.

(a) Spatial variability

As a general rule, at least 1 test per 10 acres is recommended, but as the complexity of the soil increases, more tests are needed to assure that representative values are obtained. If average conductivity values measured are less than 0.75 inch per hour, 1 test per 5 acres is recommended. The need for additional borings should be left to the discretion of the designer based on experience and good judgement.

Two 100-acre field sites are represented in figures 10–12 and 10–13. The first site (fig. 10–12) has only one soil type. This soil is uniform in texture and thickness of horizons. Based on the uniformity of the soil, the minimum amount of tests will be attempted. After the tests are performed, the uniformity of the readings determine the need for additional tests. In this example the readings are very uniform, thus no further tests are required to obtain a representative value.

The second case (fig. 10–13) is an example of having three soil types with a considerable amount of variation in characteristics (horizon thickness, texture). The complexity of the site suggests that more tests than usual will be needed, so one test will be performed per 5 acres. The initial readings were relatively uniform for soils A and B, but soil C displays a wide variation among the readings. Therefore, soil C must be explored further to obtain a representative value for permeability. It needs to be divided into smaller sections, if possible, to address as many of the limitations as are practical during the design.

Figure 10-12 A field that requires few hydraulic conductivity tests (1 per 10 acres)*

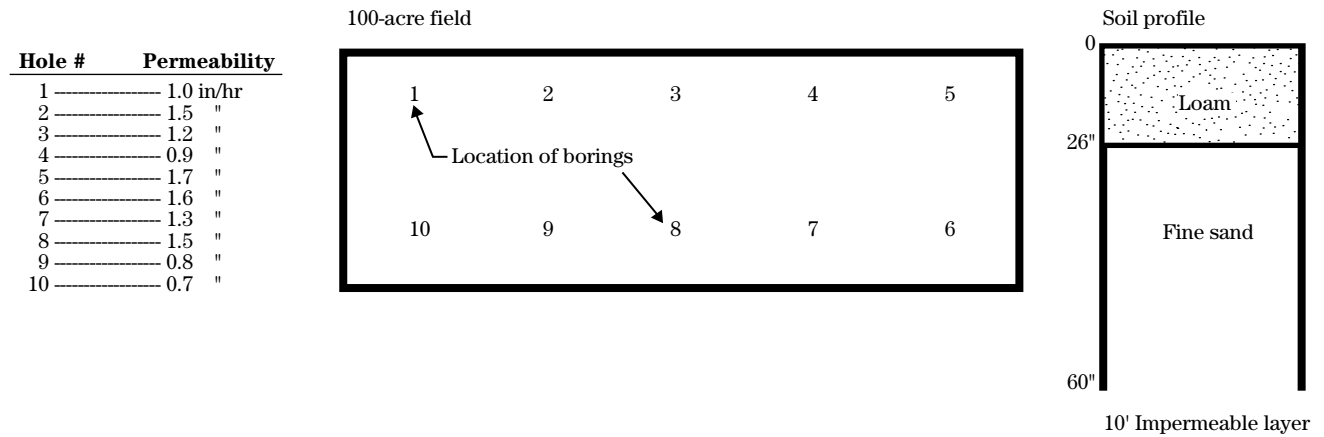

* Determining the amount of variability that can be tolerated before additional readings are needed can be left to the discretion of the designer or can be determined by a statistical analysis. Regardless of the method used, the designer must obtain a representative sample of the permeability of the field. After initial tests are performed, readings are uniform, thus no further tests are necessary.

Figure 10-13 A site that requires a variable concentration of readings based on complexity

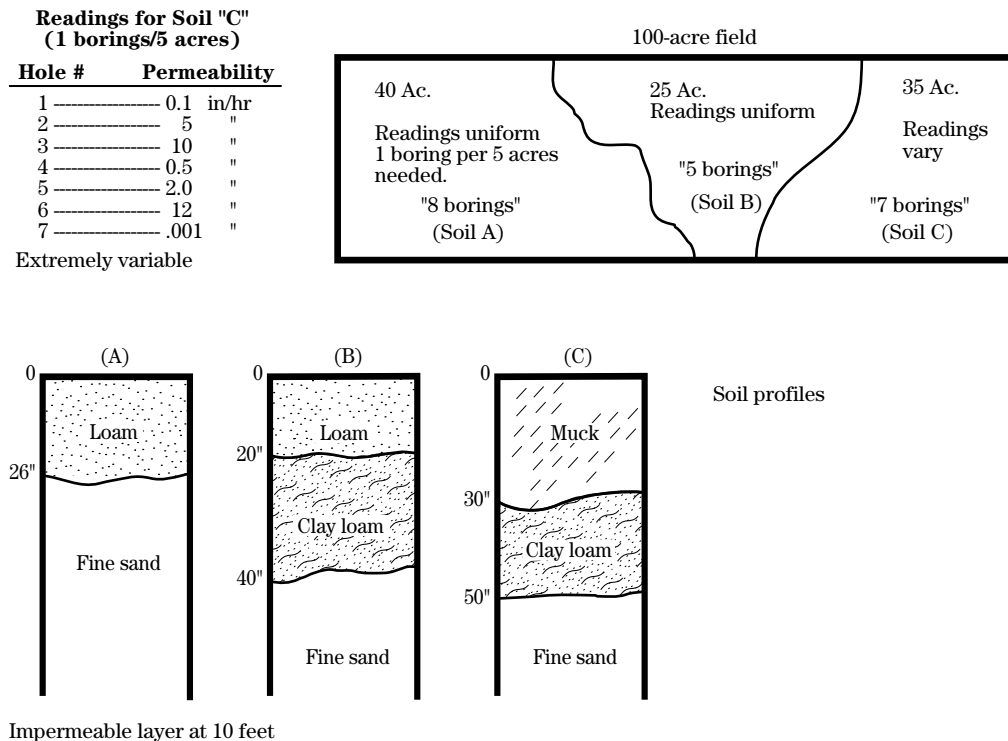

(b) Rate of conductivity for design

One rate of conductivity must be chosen for each area to be designed as a single unit. Determining the rate to be used from all the values obtained from the hydraulic conductivity tests is difficult because of variations among measurements. Simply computing the arithmetic average is not adequate for design purposes because the resulting design spacing would be less than necessary where actual conductivity is greater than the average and too wide where actual conductivity is less than the average.

The following method can help keep things simple:

- Group all of the conductivity values according to their rate of flow using the following example:

Group	Range of conductivity
Very slow	0.05 in/hr or less
Slow	0.05 to 0.5 in/hr
Moderate	0.5 to 2.0 in/hr
Rapid	2.0 in/hr or more

The designer may vary the range of these groupings based on the variability, magnitude, and arrangement of the conductivity values found in the field.

- Subdivide the field according to these groups (fig. 10–14, 10–15, 10–16, and 10–17). The conductivity value to be used for design purposes within each unit can be determined statistically or by the conductivity method described in figure 10–14. If the field can be subdivided into areas that can be designed as individual units, each unit should be based on the selected conductivity rate for that unit (fig. 10–15).
- If the field has several groups that are intertwined and cannot be subdivided into areas that can be designed as individual units, the slowest flowing groups that occupy a majority of the area should be used to determine the design value (fig. 10–16).
- If the field has several groups so closely intertwined that they cannot be subdivided into design units, use the slowest flowing group representative of the largest area to determine the design value (fig. 10–17).

Figures 10–14 to 10–17 are intended to show design considerations for conductivity and do not infer any variation because of the topography.

Figure 10–14 Using geometric mean to calculate the hydraulic conductivity value to use for design

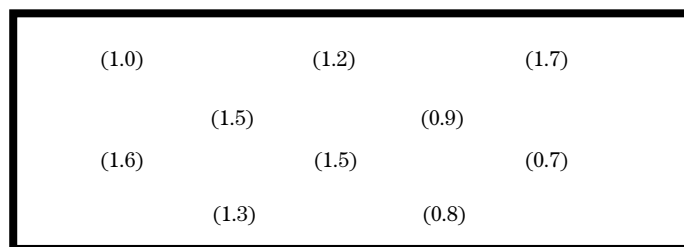

100-acre field

(1.7) indicates location of conductivity reading (in/hr) in the field

The geometric mean is slightly more conservative than the arithmetic average. This value can be used to select the design conductivity value. The geometric mean is determined by:

$$\text{Geometric mean} = \sqrt[N]{\text{all conductivity values multiplied together}}$$

Take the root of the total number of values multiplied together:

Root = Number of values (N)

Example: Design conductivity

$$\begin{aligned} \text{Design conductivity for above field} &= \sqrt[10]{1.0 \times 1.5 \times 1.2 \times .9 \times 1.7 \times 1.6 \times 1.3 \times 1.5 \times .8 \times .7} \\ &= 1.2 \text{ in/hr} \end{aligned}$$

Figure 10-15 Delineating the field into design units based on conductivity groupings

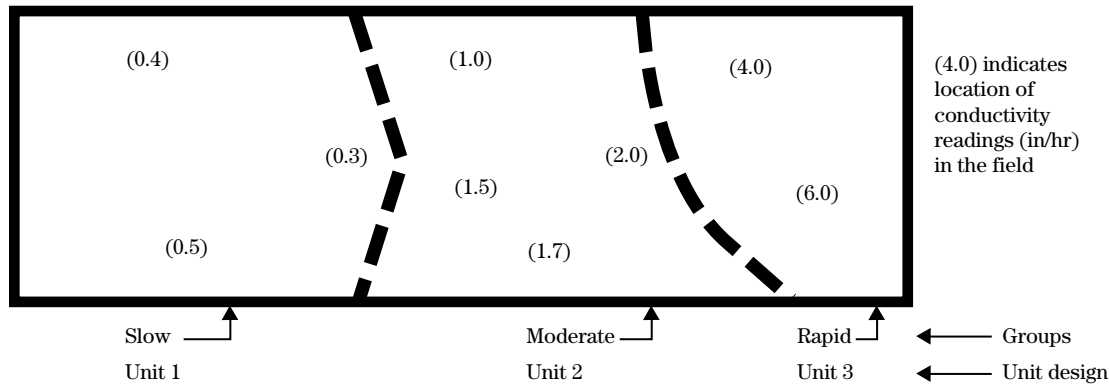

This field can be subdivided into three groups. Each group can then be designed as a single unit. Use the following formulas to determine the rate of conductivity to use for each design unit:

Unit 1 $\sqrt[3]{0.4 \times 0.3 \times 0.5} = 0.39 \text{ in/hr}$
 Unit 2 $\sqrt[4]{1.0 \times 2.0 \times 1.5 \times 1.7} = 1.5 \text{ in/hr}$
 Unit 3 $\sqrt[2]{4.0 \times 6.0} = 4.9 \text{ in/hr}$

These values will be used for the design of Units 1, 2, and 3.

Figure 10-16 Delineating the field into design units based on conductivity groupings*

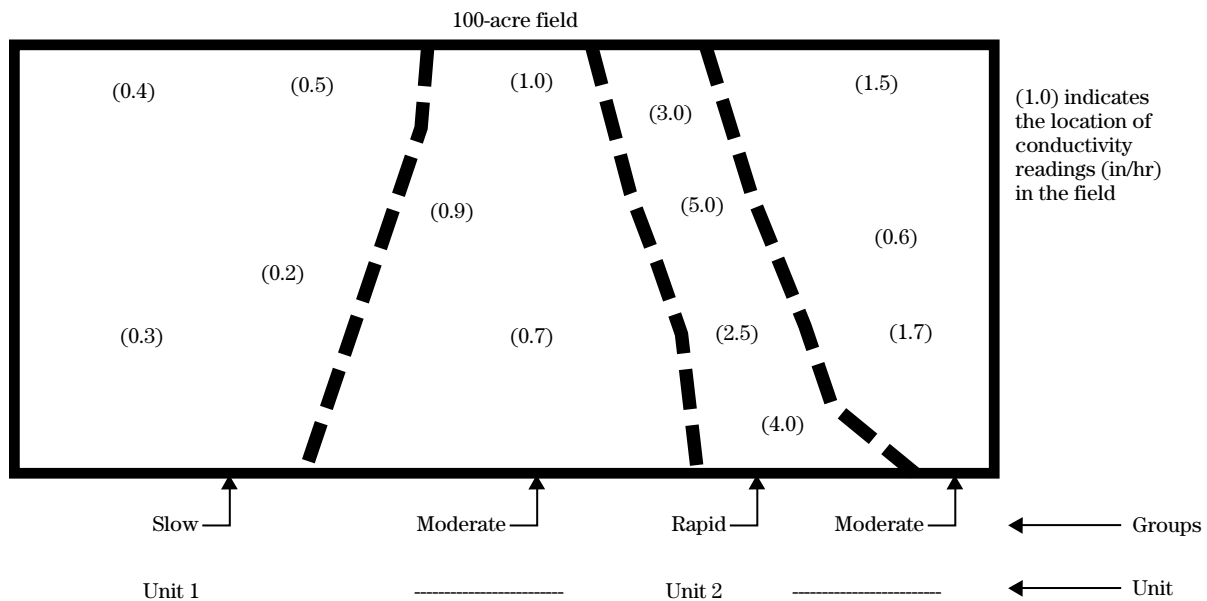

This field has three groups, but should be divided into two design units. Unit 2 should be designed using the moderate values because these values are the most restrictive and occupy a majority of the area. Ignore the "rapid" values because this area of the field cannot be designed separately.

Determine the rate of conductivity to be used for design of each unit by:

Unit 1 (slow) $\sqrt[4]{0.4 \times 0.3 \times 0.2 \times 0.5} = .033 \text{ in/hr}$
 Unit 2 (moderate) $\sqrt[6]{0.7 \times 0.9 \times 1.0 \times 1.7 \times 0.6 \times 1.5} = 1.0 \text{ in/hr}$

* The narrow band of rapid values cannot be practically treated as a separate unit.

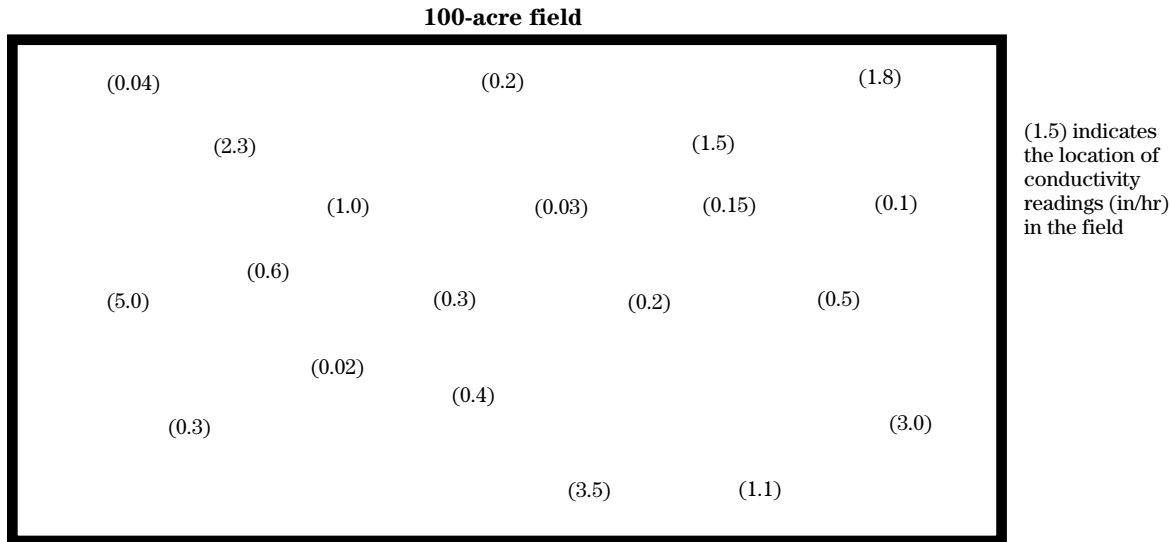
Figure 10-17 Delineating the field into design units based on conductivity groupings

Because of the random variation in readings, more than one measurement per 10 acres is needed. This field cannot be subdivided because the values are too randomly distributed. The entire field must be designed as one unit.

Group	Values (in/hr)
Very slow	0.04, 0.03, 0.02
Slow	0.2, 0.3, 0.4, 0.3, 0.1, 0.2, 0.15, 0.5
Moderate	1.0, 1.5, 1.1, 1.8, 0.6
Rapid	3.0, 5.0, 2.3, 3.5

The very slow group is represented, but there are only three values and these values are much lower than the values in the slow group. If there is any doubt that these values only represent an insignificant area of the field, more tests should be performed in the vicinity of these readings to better define the area of very slow conductivity rates. The rapid values are much higher than the majority of the other values and should not be used. It is not obvious for this example whether or not to discard the moderate values or group the slow and moderate values together. Using only the slow values will result in a more conservative design.

Determine the conductivity value to be used for the design:

Use the slow values, discarding the very slow, moderate, and rapid values.

$$\sqrt[8]{0.2 \times 0.3 \times 0.4 \times 0.3 \times 0.1 \times 0.2 \times 0.15 \times 0.5} = 0.24 \text{ in / hr}$$

(c) Performing hydraulic conductivity tests

(1) Auger-hole method

The auger-hole method is the simplest and most accurate way to determine soil permeability (fig. 10–18). The measurements obtained using this method are a combination of vertical and lateral conductivity, however, under most conditions, the measurements represent the lateral value. The most limiting obstacle for using this method is the need for a water table within that part of the soil profile to be evaluated. This limitation requires more intensive planning. Tests must be made when a water table is available during the wet season. Obtaining accurate readings using this method requires a thorough knowledge of the procedure. The auger-hole method is not reliable when the hole penetrates a zone under plezometric pressure.

The principle of the auger-hole method is simple. A hole is bored to a certain distance below the water table. This should be to a depth about 1 foot below the average depth of drains. The depth of water in the hole should be about 5 to 10 times the diameter of the hole. The water level is lowered by pumping or bailing, and

the rate at which the ground water flows back into the hole is measured. The hydraulic conductivity can then be computed by a formula that relates the geometry of the hole to the rate at which the water flows into it.

(i) Formulas for determination of hydraulic conductivity by auger-hole method—Determination of the hydraulic conductivity by the auger-hole method is affected by the location of the barrier or impermeable layer.

A barrier or impermeable layer is defined as a less permeable stratum, continuous over a major portion of the area and of such thickness as to provide a positive deterrent to the downward movement of ground water. The hydraulic conductivity of the barrier must be less than 10 percent of that of the overlying material if it is to be considered as a barrier. For the case where the impermeable layer coincides with the bottom of the hole, a formula for determining the hydraulic conductivity (K) has been developed by Van Bavel and Kirkham (1948).

$$K = \left(\frac{2220r}{SH} \right) \left(\frac{\Delta y}{\Delta t} \right) \quad [10-1]$$

Figure 10–18 Symbols for auger-hole method of measuring hydraulic conductivity

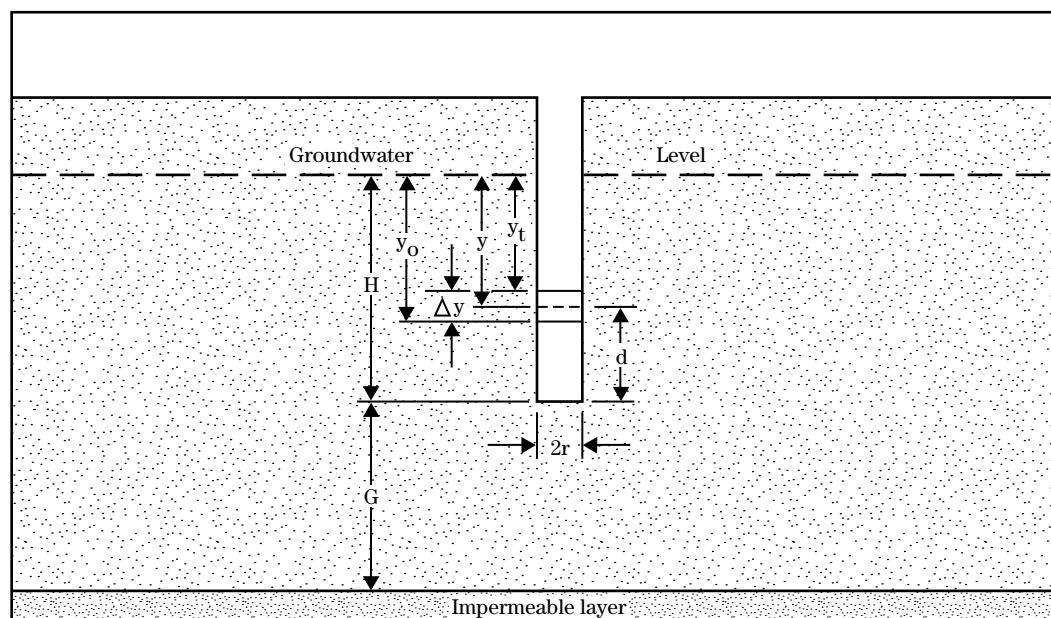

where:

- S = a function dependent on the geometry of the hole, the static depth of water, and the average depth of water during the test
 K = hydraulic conductivity (in/hr)
 H = depth of hole below the ground water table (in)
 r = radius of auger hole (in)
 y = distance between ground water level and the average level of water in the hole (in) for the time interval t (s)
 Δy = rise of water (in) in auger hole during Δt
 t = time interval (s)
 G = depth of the impermeable layer below the bottom of the hole (in). Impermeable layer is defined as a layer that has the permeability of no more than a tenth of the permeability of the layers above.
 d = average depth of water in auger hole during test (in)

A sample form for use in recording field observations and making the necessary computations is illustrated in figure 10-19. This includes a chart for determining the geometric function S for use in the formula for calculation of the hydraulic conductivity.

The more usual situation is where the bottom of the auger hole is some distance above the barrier. Formulas for computing the hydraulic conductivity in homogeneous soils by the auger-hole method have been developed for both cases (Ernst, 1950). These formulas (10-2 and 10-3) are converted to English units of measurement.

For the case where the impermeable layer is at the bottom of the auger-hole, $G = 0$:

$$K = \frac{15,000r^2}{(H + 10r)\left(2 - \frac{y}{H}\right)y} \frac{\Delta y}{\Delta t} \quad [10-2]$$

For the case where the impermeable layer is at a depth $\geq 0.5H$ below the bottom of the auger hole:

$$K = \frac{16,667r^2}{(H + 20r)\left(2 - \frac{y}{H}\right)y} \frac{\Delta y}{\Delta t} \quad [10-3]$$

The following conditions should be met to obtain acceptable accuracy from use of the auger-hole method:

- $2r > 2 \frac{1}{2}$ and $< 5 \frac{1}{2}$ inches
- $H > 10$ and < 80 inches
- $y > 0.2 H$
- $G > H$
- $y < \frac{1}{4} y_0$

Charts have been prepared for solution of equation 10-3 for auger-holes of $r = 1 \frac{1}{2}$ and 2 inches. For the case where the impermeable layer is at the bottom of the auger hole, the hydraulic conductivity may be determined from these charts by multiplying the value obtained by a conversion factor f as indicated on figure 10-20.

Figure 10-19 Auger-hole method of measuring hydraulic conductivity—sheet 1 of 2

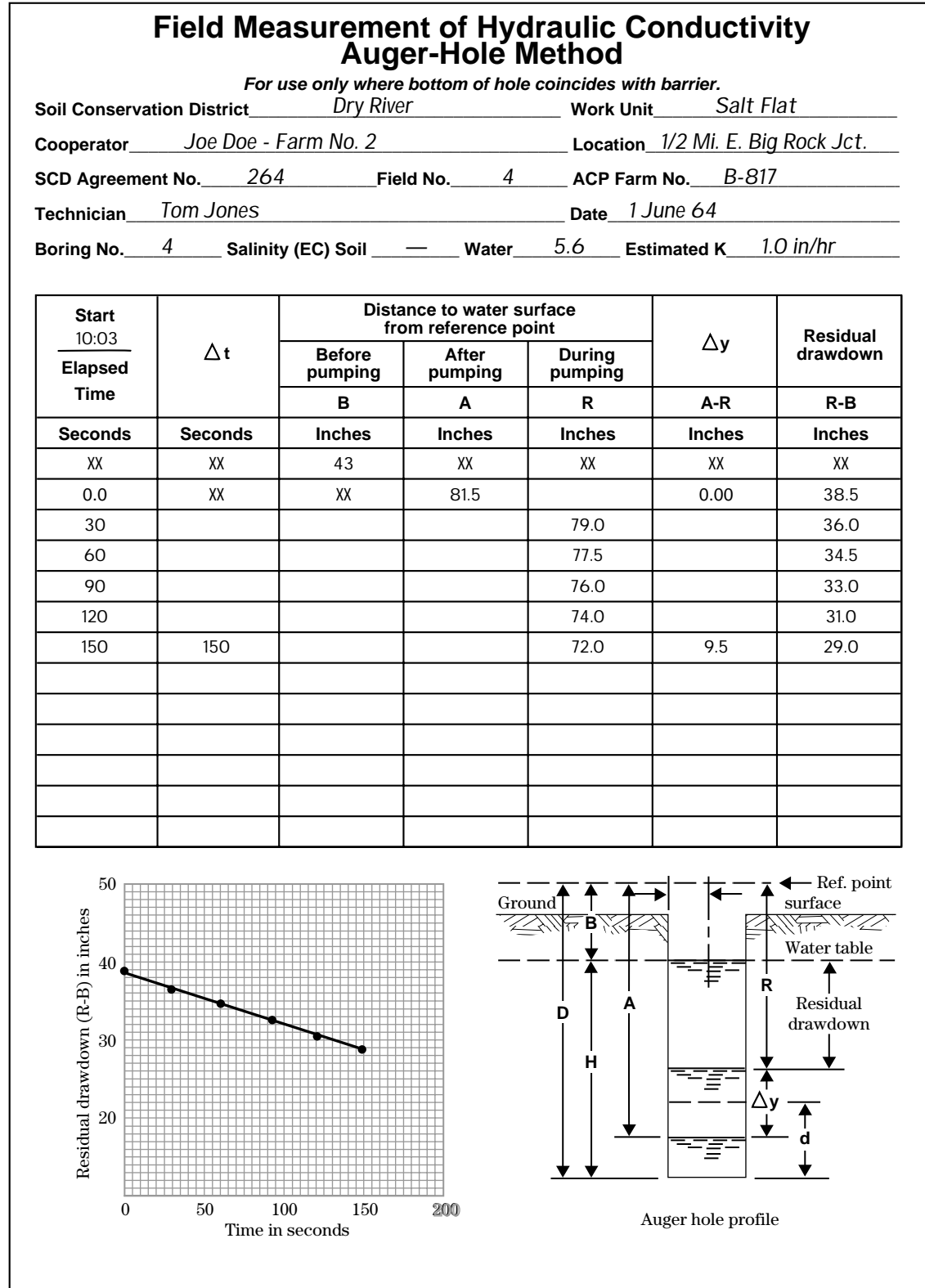

Figure 10-19 Auger-hole method of measuring hydraulic conductivity—sheet 2 of 2

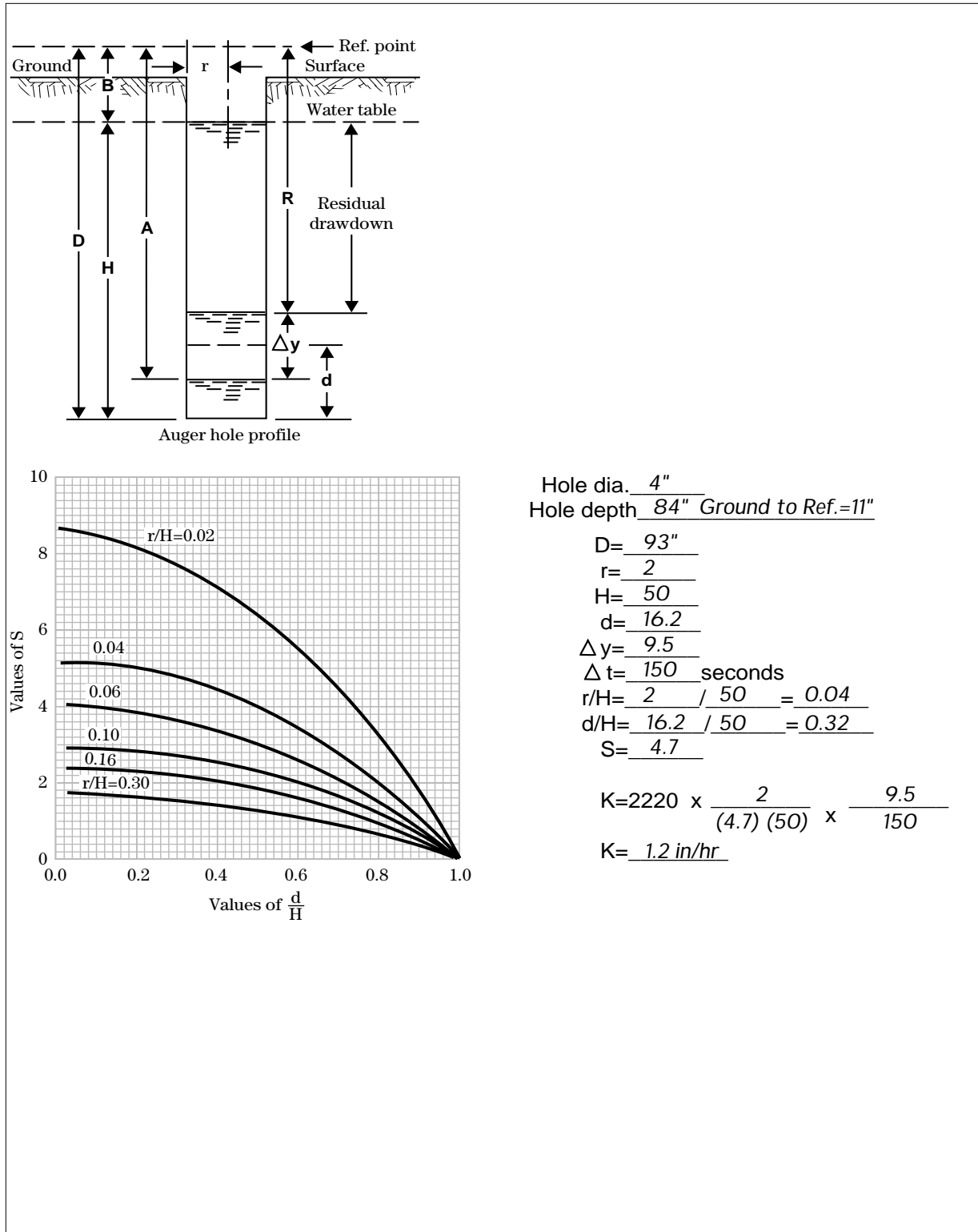

Figure 10-20 Hydraulic conductivity—auger-hole method using the Ernst Formula

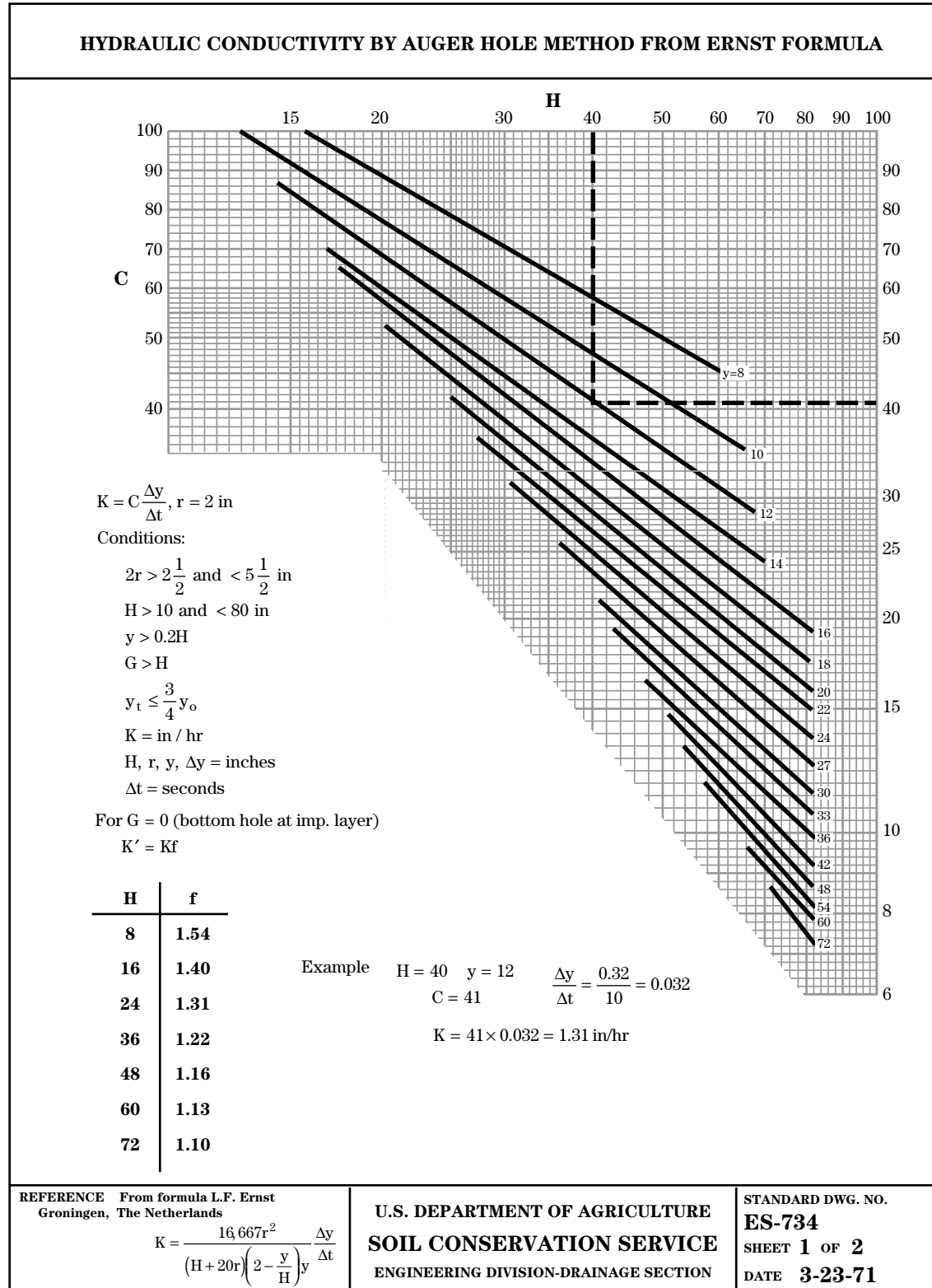
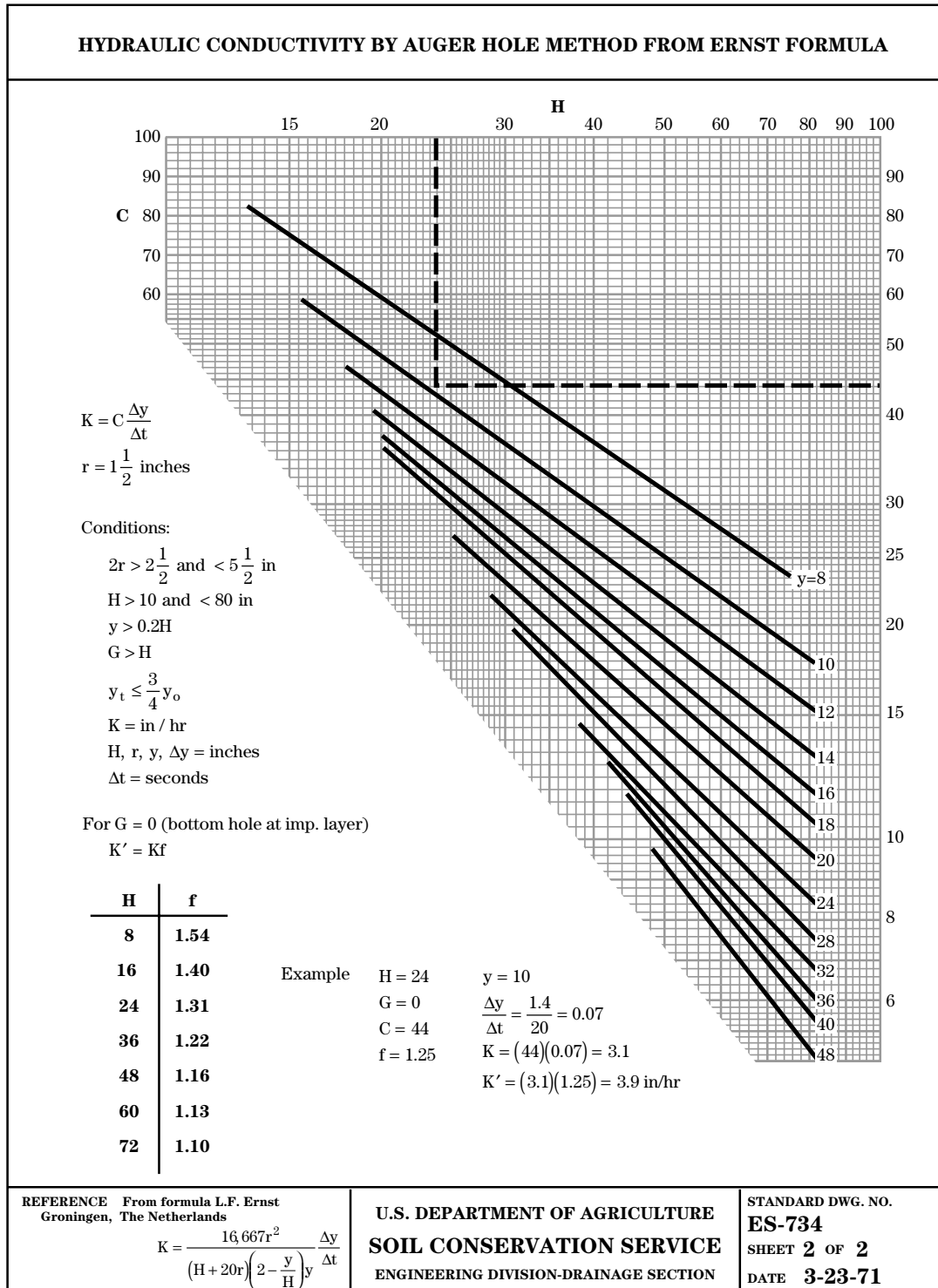

Figure 10-20 Hydraulic conductivity—auger-hole method by Ernst Formula—Continued



(ii) Equipment for auger-hole method—The following equipment is required to test hydraulic conductivity:

- suitable auger
- pump or bail bucket to remove water from the hole
- watch with a second hand
- device for measuring the depth of water in the hole as it rises during recharge
- well screen may be necessary for use in unstable soils

Many operators prefer a well made, light weight boat or stirrup pump that is easily disassembled for clean-

ing. A small, double diaphragm barrel pump has given good service. It can be mounted on a wooden frame for ease of handling and use.

For the depth measuring device, a light weight bamboo fishing rod marked in feet tenths and hundredths and that has a cork float works well. Other types of floats include a juice can with a standard soldered to one end to hold a light weight measuring rod.

A field kit for use in making the auger hole measurement of hydraulic conductivity is illustrated in figure 10-21. In addition to the items indicated in this figure, a watch and a soil auger are needed.

Figure 10-21 Equipment for auger-hole method of measuring hydraulic conductivity

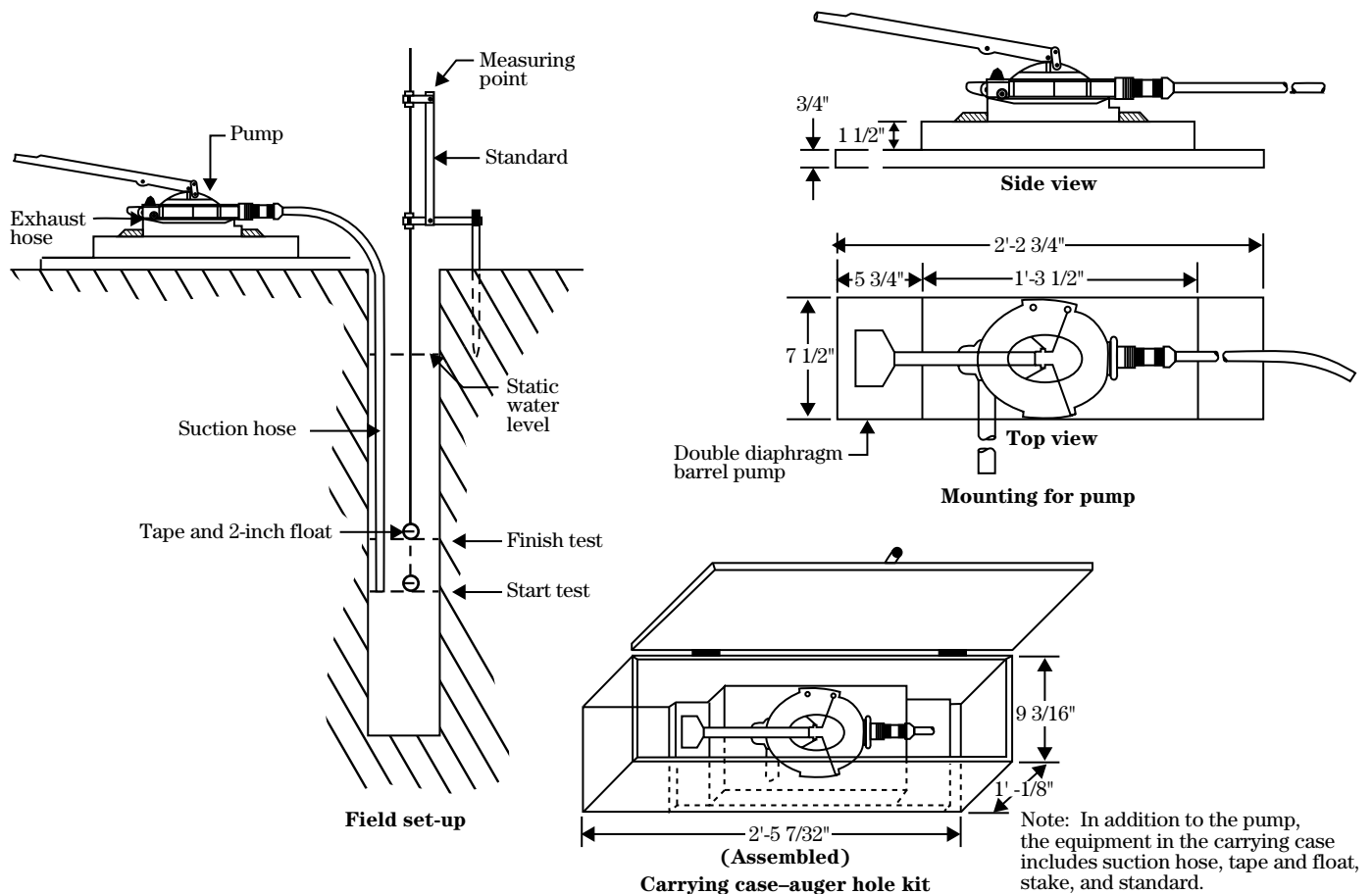

A perforated liner for the auger-hole is needed in making the auger-hole measurement in fluid sands. This liner keeps the hole open and maintains the correct size. Several types of liners are used successfully. Adequate slot openings or other perforations must be provided to allow free flow into the pipe.

The openings in the screen should not restrict flow appreciably. The head loss through the screen should be negligible, and the velocity of flow through the openings should be small (0.3 foot per second or less) to prevent movement of fines into the hole. These criteria generally are met if the area of openings is 5 percent or more of the total area of the screen.

The Bureau of Reclamation uses 4-inch downspouting with 60 1/8- by 1-inch slots per foot of length. This works well in a variety of soils. A screen from the Netherlands is made from a punched brass sheet 2 millimeters thick with holes averaging about 0.5 millimeter in diameter. It is rolled into a tube 8 centimeters in diameter by 1 meter long. This screen works well because the sheet is rolled so that the direction in which the holes are punched is outward and the holes are variable in size. It has been used in many troublesome soils, and no clogging or failure to keep fines out of the hole has been reported.

Good judgment is needed in determining how far to drawdown the water level in the auger hole for the test. A minimum drawdown is necessary to physically satisfy theoretical criteria (refer to constraints given in figure 10–20). Generally, a larger drawdown should be made for slowly permeable soils than that for more permeable soils. A small drawdown for holes in sloughing soils may reduce the amount of sloughing. To prevent picking up sand in the pump, pumping should stop when the water level is within a few inches of the bottom of the hole.

Measurement of the rate of recovery of water in the auger hole should be completed before a fourth of the total amount of drawdown has been recovered (10). Four or five readings should be taken at uniform short time intervals, and a plot of the readings made to determine a uniform rate of recovery to use in the formula. Plotting of time in seconds against the residual drawdown in inches indicates those readings at the beginning and end of the test that should be discarded and the proper values of t and y to use.

(2) Double tube method

The double tube method for determining the hydraulic conductivity in the absence of a water table has been developed by Bouwer (1962). The principle, method, and equipment required for this method for field measurement of hydraulic conductivity of soil above a water table are discussed in the reference and will not be addressed in this handbook. Resulting measurements are less precise than measurements in a water table because of the slow adjustments that must take place from capillary movement and air entrapment within the soil-pore space.

(3) Well permeameter method

The Well Permeameter Method is a field test for determining the permeability of soil in place is used by the Bureau of Reclamation (17). This method, consisting of measuring the rate at which water flows outward from an uncased well under constant head, is particularly useful for estimating the need for lining an irrigation canal before construction. The apparatus required for the test and the procedure are described in the Bureau's Earth Manual.

(4) Velocity Permeameter method

The Velocity Permeameter (VP) was developed at Michigan State University. The VP makes use of the Darcy Law for flow of fluid through a porous medium. The device consists of a sampling cup that is driven some fairly short distance " s " into the soil. The sampling cup is then attached to a head tube full of water which is allowed to flow into the soil trapped within the cup. The rate of change of fall of water in the head tube, h , is a function of the rate, v , at which water flows through the soil. The rate is determined using a hand-held calculator. This information is then used to determine the permeability according to:

$$v = K \frac{h}{s}$$

which, after differentiating with respect to h and solving for K becomes:

$$K = \frac{dv}{dh} \times s$$

The head tube diameter is several times smaller than the diameter of the sampling cup, and this magnifies the rate at which water flows into the soil trapped within the sampling cup.

(i) Advantages—The chief advantages of the Velocity Permeameter are the speed with which a determination can be made, the repeatability of the determination, the range of permeabilities that can be determined, and the fact that lateral and vertical conductivity measurements can be made individually. Each of these points are described in this section.

A single determination of permeability using the Velocity Permeameter is dependent on the time required to field-saturate the soil within the sampling cup. This usually requires no more than 15 minutes. During this time the head tube is refilled several times and several measurements are taken. The result of each measurement is a value that becomes progressively less than the preceding value and tends to an asymptotic value. When several determinations agree, the cup has become saturated and a determination has been made.

The repeatability of the measurements is very good. All measurements made at a single location in a single profile agree to within one or two significant digits. Work by Rose and Merva (1990) comparing laboratory and field measurements yielded a coefficient of determination of 98 percent.

The permeameter comes with several diameter sampling cups and head tubes giving it a wide range of application. As obtained from the manufacturer, it has a range of permeability determinations from 0.001 m/h to 0.76 m/h.

Lateral conductivities are obtained by "jacking" the sampling cup into the vertical face of an exposed soil profile. Once the cup has been inserted into the soil, the measurement proceeds as above.

(ii) Limitations—As with any device, certain limitations exist. Because the measurement is a point measurement, multiple measurements must be made to delineate the conductivity of an area. Within a horizon in a given soil series, however, measurements are repeatable and, based on the variation between readings, the user can estimate a value to be used.

A more pressing problem is the presence of cracks and biopores (wormholes, root channels). This problem exists with virtually all methods of measurement short of measuring the hydraulic conductivity through tile outflow. Careful insertion of the sampling cup helps to avoid all but the most contaminated location, and facilitates the determination of permeability.

(d) Estimating hydraulic conductivities

If auger hole measurements cannot be performed because a water table is not present, one of the other methods should be selected. The designer must be aware that the conductivity can vary significantly within the same soil in any given field, thus estimates should be used carefully.

Estimates can be made using the Soil Interpretation Records for each soil as shown in figure 10–22.

Figure 10-22 Estimating the overall conductivity using estimated permeabilities from the Soil Interpretation Record

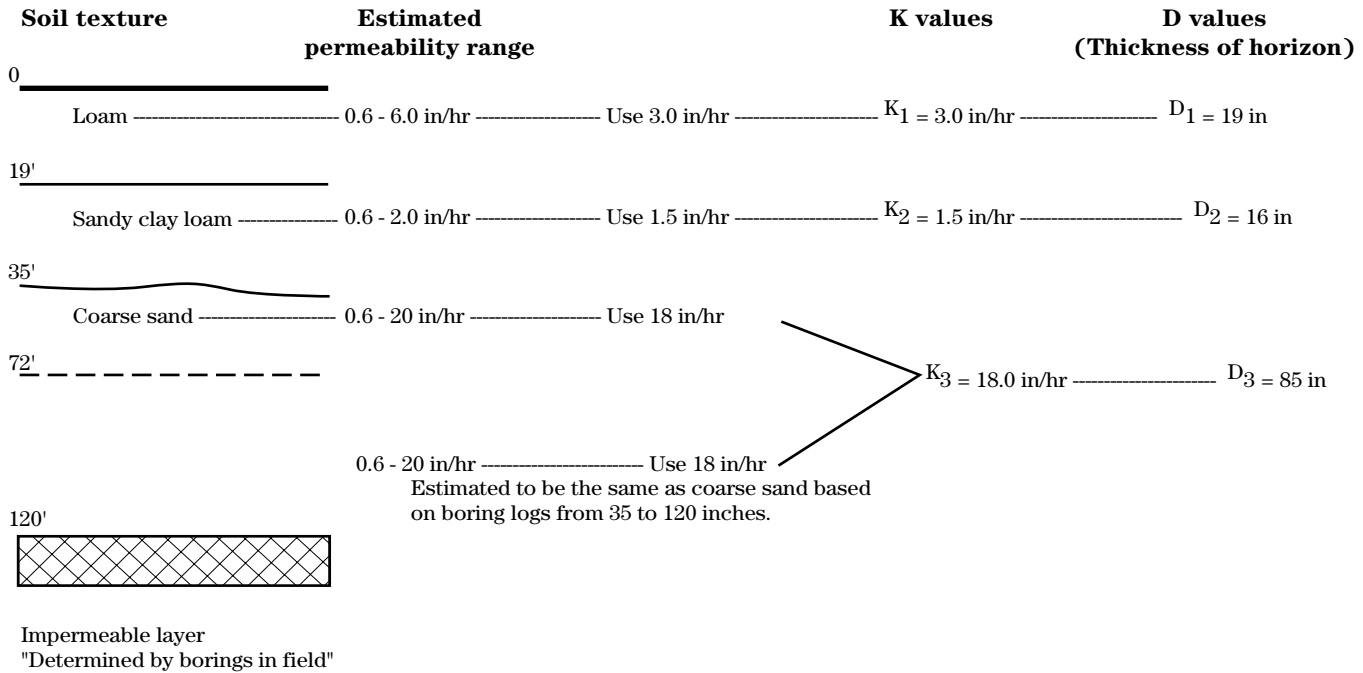

Solve for saturated lateral conductivity

$$K_e = \frac{D_1 K_1 + D_2 K_2 + \dots + D_n K_n}{D_1 + D_2 + \dots + D_n}$$

$$K_e = \frac{19 \text{ in} \times 3.0 \text{ in/hr} + 16 \text{ in} \times 1.5 \text{ in/hr} + 85 \text{ in} \times 18 \text{ in/hr}}{19 \text{ in} + 16 \text{ in} + 85 \text{ in}}$$

$$K_e = \frac{1611}{120} = 13.4 \text{ in/hr}$$

(e) Determine the depth to the impermeable layer

In the field, the depth to the impermeable layer (horizon) is usually determined by boring holes and observing the textural changes that occur between horizons. The textural change is abrupt in some soils. In other soils where the textural change occurs very gradually, the depth to the impermeable layer is difficult to determine. Generally, an impermeable layer is considered to be where the permeability is in the order of one tenth of the layer above.

In many cases the depth to the impermeable layer cannot be determined without a drill rig. Unfortunately, the use of a drill rig on many sites is impractical. As a result, holes are bored 10 to 15 feet deep with hand augers. If an impermeable layer is not found, it is considered to be the deepest point of penetration. This results in a conservative design, which will be adequate (fig. 10-23).

624.1004 Design

If the site has met the required conditions to establish a water table control, the next step is to design the type of system that is desired.

(a) Farm planning and system layout

The entire farm must be considered, and the area impacted by the control of the drainage outlet should be delineated. A survey of the affected area is needed to determine the topographic limitations, locate the position of structures, orient underground conduits and/or ditches with respect to the slope, determine the need for land smoothing or grading, and separate the farm, or field, into zones that can be managed individually.

Figure 10-23 Determining depth to impermeable layer (a) when the impermeable layer is abrupt, (b) when the impermeable layer is difficult to recognize, and (c) when the impermeable layer is too deep to find with a hand auger

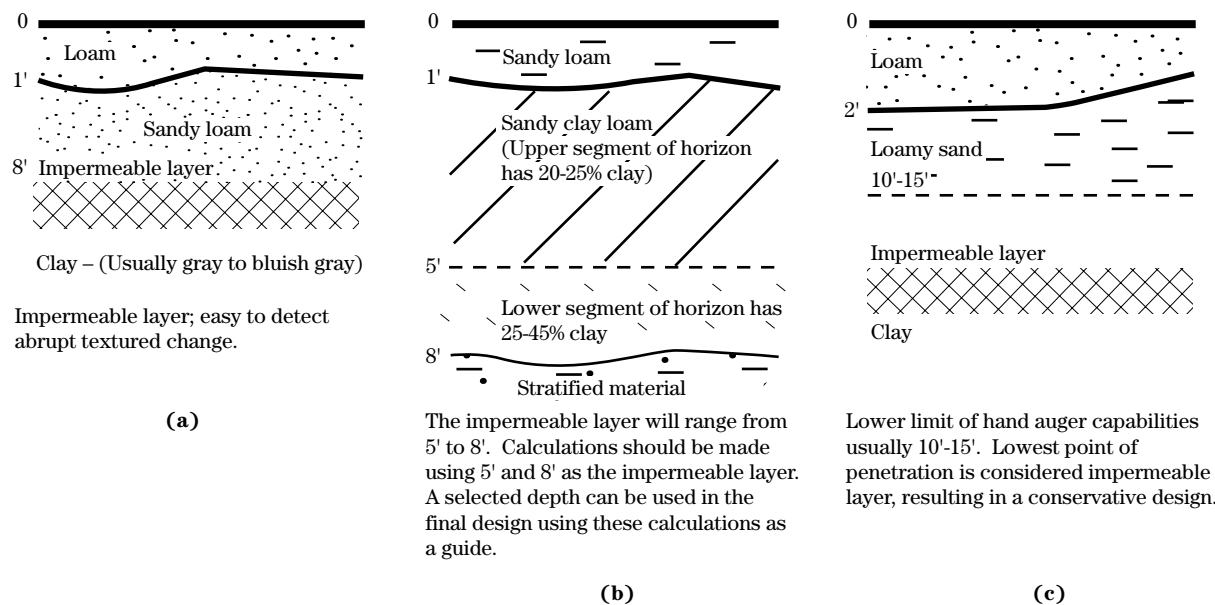

(1) Example farm plan

Figure 10-24 illustrates a 280-acre farm that has been surveyed and planned. The soils are excellent for water table control, and initially the entire farm has been subdivided into seven fields (A through G). The

flow of water is constant, even during extremely dry periods, through the main canals that dissect the farm. This water is from a fresh water lake that provides enough water to irrigate the entire farm. No other farms will be affected by controlling the water table.

Figure 10-24 General farm layout

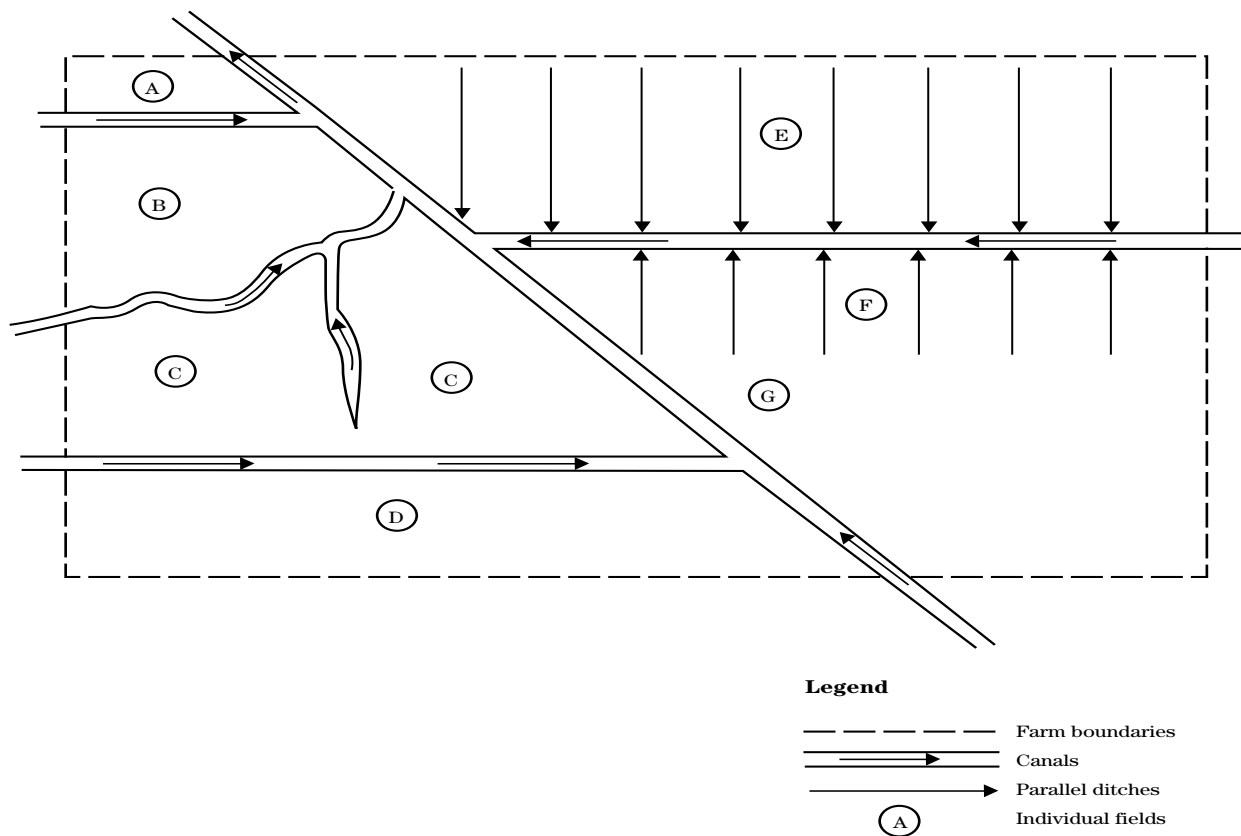

Entire farm - 280 acres

Field	Needs
A — 11 acres	Drainage and irrigation
B — 26 acres	Drainage and irrigation
C — 30 acres	Drainage and irrigation
D — 44 acres	Drainage and irrigation
E — 70 acres	Irrigation
F — 40 acres	Irrigation
G — 59 acres	Irrigation

A survey is made (fig. 10-25), and elevations are determined for areas of obvious depressions and ridges. From these elevations, decisions can be made concerning the placement of water control structures and regarding the need for more intensive surveys where landgrading is required. Fields B, C, and D have large depressions and require more intensive surveys to properly grade the land. Fields E and F are dissected by parallel ditches. Each field between the parallel ditches is crowned at about 0.5 foot, thus eliminating the need for extensive landgrading. Field G has slopes that are uniform, but change abruptly. This field requires no land shaping because the slope is uniform.

Corn, soybeans, and wheat are the principal crops grown on the farm, and for subirrigation a 1 foot contour interval should suffice. However, when high value crops, such as vegetables, are grown, a half-foot contour interval is needed. The farm has been subdivided based on 1-foot contour intervals (fig. 10-26). The areas within each interval are considered to be management zones. These contour intervals were flagged in the field the same day the survey was made by determining the lowest side of the farm and locating the lowest contour interval on the ground, which for this example was 4.4 feet. The remaining 1-foot contour intervals, 5.4, 6.4, 7.4, 8.4, and 9.4 feet were located and staked in the field. Using this method, the landowner is able to see the farm layout and decisions can be made immediately.

Figure 10-25 Initial survey to determine general layout of the farm (elevations taken in obvious depressions and on ridges)

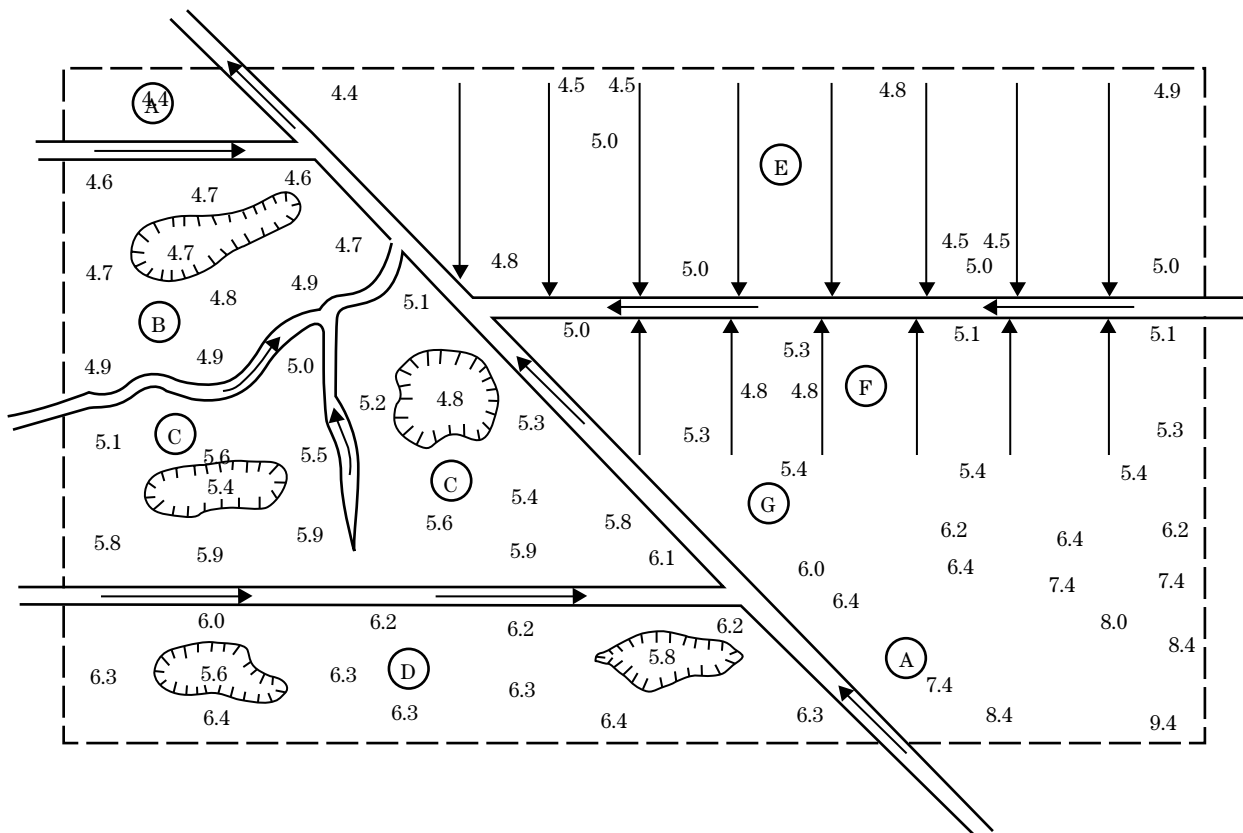
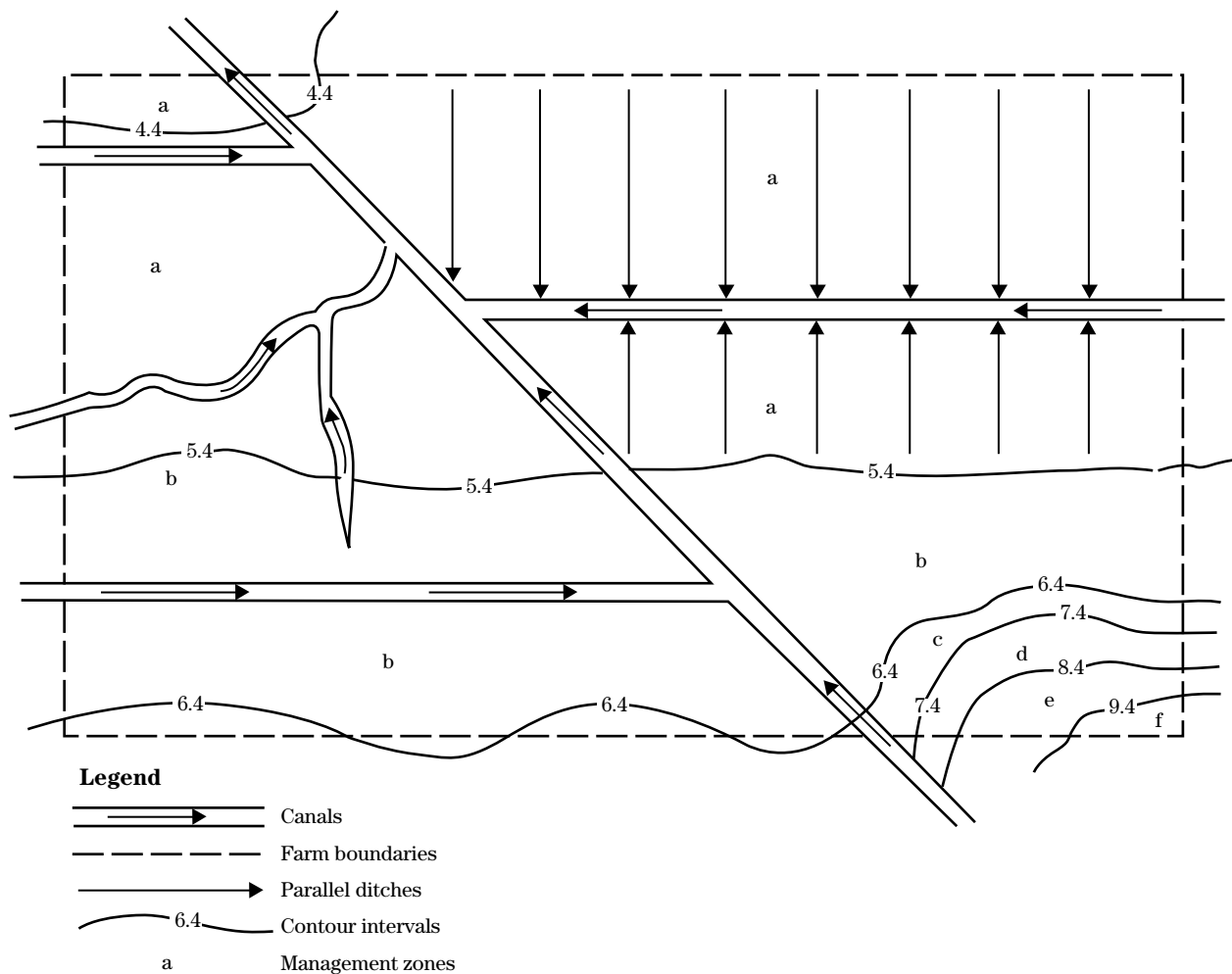

Figure 10-27 illustrates an approach for properly staging the water tables on this farm. Using this example, the farm is subdivided into management zones based on the 1-foot contour intervals. Water control structures are to be placed in the major drainage canals at the intersection of each contour interval. A flashboard riser will be placed in the canal at the 4.4- and 5.4-foot contour intervals. These zones constitute an open system.

The remaining zones will be controlled by water control structures located on subsurface drain outlets in the field at the remaining contour intervals at 6.4-, 7.4-, 8.4-, and 9.4-foot (use 0.5-foot intervals for high value crops or crops with shallow root systems). These zones constitute a closed system.

Figure 10-26 Contour intervals determined and flagged in field*



* These intervals are easily determined and are used to locate structures and subdivide the farm into management zones. Zones e and f may not be economically feasible because only a small acreage is affected.

Figure 10-27 Farm plan based on topographic survey

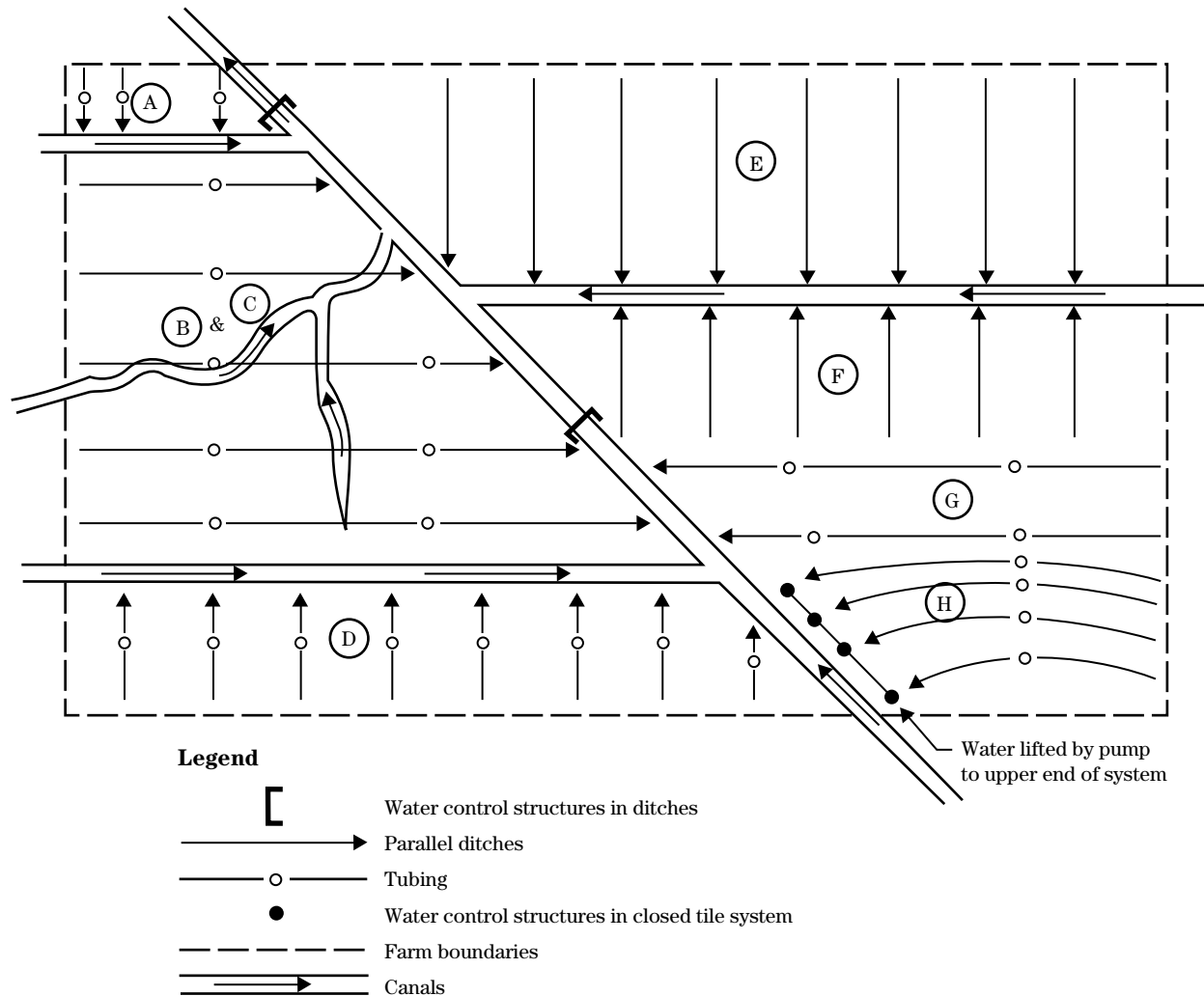

Field Plan

- A Will have tubing installed for drainage and subirrigation.
- B & C Will be combined by removing the ditch, grading, and installing tubing for drainage and subirrigation.
- D Will be shaped and graded with tubing installed for drainage and subirrigation.
- E The parallel ditches will remain and be used as a subirrigation system. Landgrading will not be required.
- F The parallel ditches will remain and be used as a subirrigation system. Landgrading will not be required.
- G Will be subdivided with tubing installed in the lower part for drainage and subirrigation.
- H Has an abrupt uniform slope change, so closed system of tubing will be used to stage the water table across the slope for subirrigation.

Field A is relatively flat and needs drainage and irrigation. Tubing will be installed. The water table will be controlled from the flashboard riser at the 4.4-foot contour interval. Fields B and C will be combined by removing the ditch and installing tubing for subirrigation and drainage. Both fields will be graded. The water table will be controlled on 75 percent of the field by the flashboard riser at the 4.4-foot contour interval. The remainder of the field is above the 5.4-foot contour interval and will be controlled by the flashboard riser at that interval.

Field D will have tubing installed to meet the drainage and subirrigation requirements. This field will be graded. The water table will be controlled by the flashboard riser at the 5.4-foot contour interval.

Fields E and F will not require landgrading. These fields are subdivided into the individual units by parallel ditches and they are crowned at about a half foot between ditches. Careful evaluation of the soil properties has shown that this system of parallel ditches can be used as a subirrigation system. The water table for both fields will be managed by the flashboard riser in the canal at the 4.4-foot contour interval.

Field G has been further divided into two areas. The lower area will have tubing installed for subirrigation and drainage. This area will not require landgrading. The water table will be controlled by the flashboard riser located in the canal at the 5.4-foot contour interval.

The upper part of area H exhibits a uniform slope of about 1 percent. This area will not require landgrading, but will require that the water table be staged over a 4-foot change in elevation. To properly stage the water tables, water control structures will be installed on the tubing system at the 6.4-, 7.4-, 8.4-, and 9.4-foot contour intervals, resulting in four separate management zones. All four zones will be drained to an outlet in the canal immediately below the 6.4-foot contour interval. For subirrigation, water will be pumped into the upper end of the system at the 9.4-foot contour interval and allowed to flow over the weir at each contour interval until the entire zone is properly irrigated.

Each of the six zones within the farm will be managed independently. The management scheme will be based on a water management plan.

(b) Root zone

The root zone depth of all crops to be grown must be known. If it is not known, a detailed evaluation is recommended. Pits should be dug when crops are near maturity or at critical stages to make these determinations. Use figure 10-28 for guidance if estimates must be made. Root zones may be restricted by dense soil layers or water tables.

The depth of the root zone influences how the water table control is designed and managed. Normally, 70 percent of moisture extraction is from the upper half of the root zone of most plants (figs. 10-28 and 10-29). This usually is the top foot of the root system on shallow rooted crops (USDA 1971). Assuming an unrestricted root zone, the upper half of the root zone should be used as the effective root zone for design and management of water table control.

Figure 10-29 Percent moisture extraction from the soil by various parts of a plant's root zone

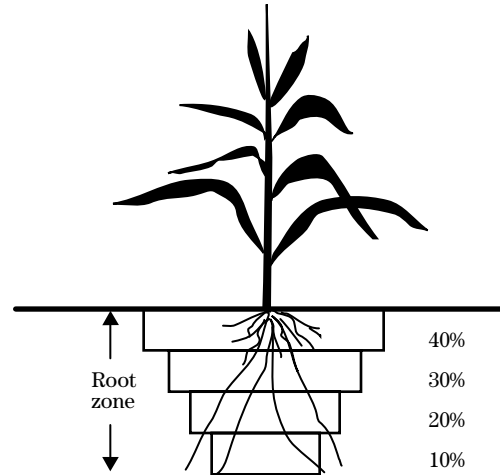
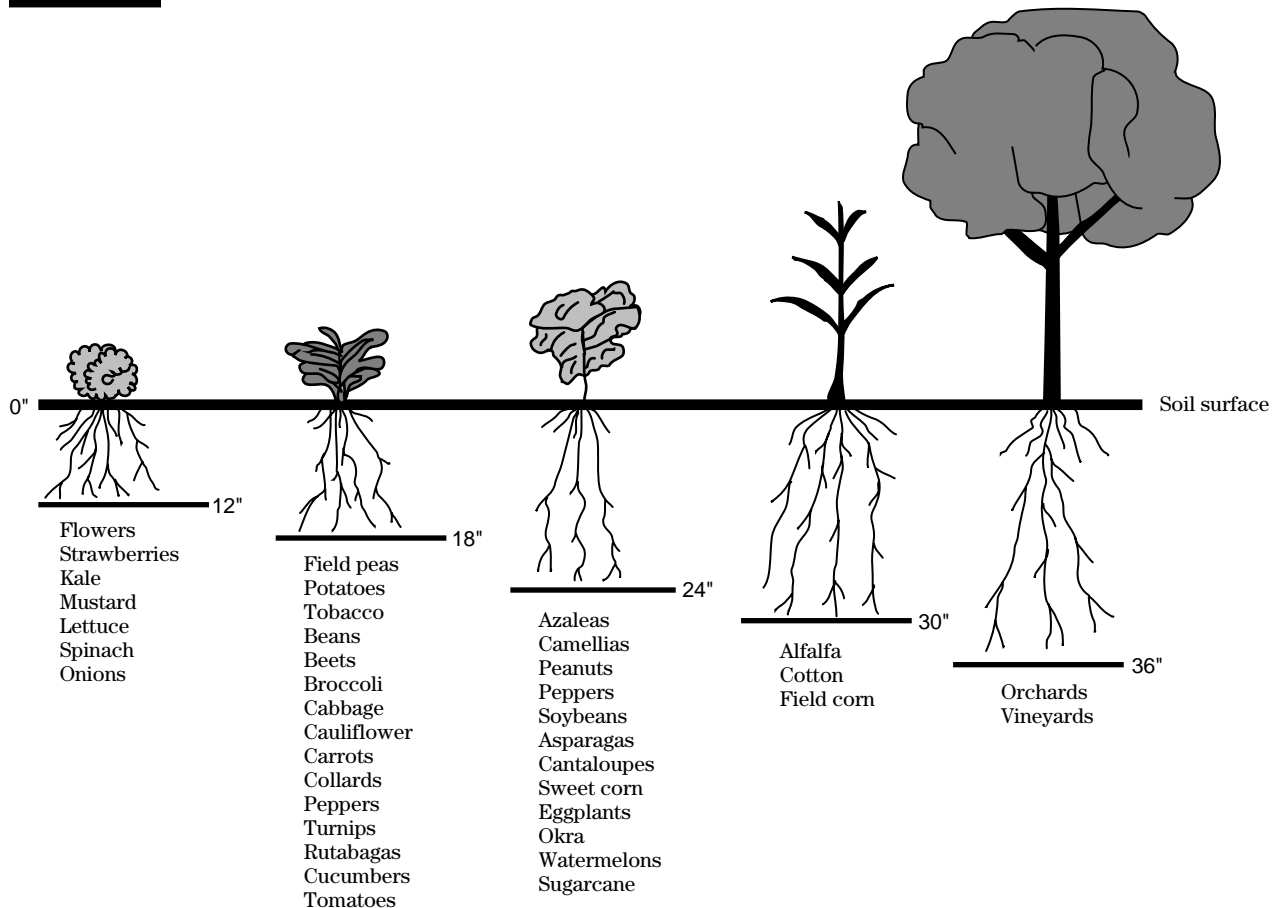

Figure 10-28 Typical rooting depths for crops in humid areas*



*This is only a guide. Local rooting depths should be determined.

(c) Estimating water table elevation and drainage coefficients

A determination of the optimum water table elevation is necessary for design and management of a water table control system. Several factors influence this optimum level. As discussed in the previous section, effective rooting depth is important. This must be considered in conjunction with the soil's ability to vertically transmit water into the effective root zone from the water table. Because the soil offers some resistance to water movement, the water table will not be perfectly horizontal between ditches or drains. During drainage the water table is higher between drains than directly over the drain, and during subirrigation the reverse is true. As a result the tolerable rate of drawdown during drainage and the allowable sag during subirrigation become important factors of the design.

(1) Determining needed drawdown

Drainage coefficients are used in determining the design capacity of a system. The drainage coefficient is that rate of water removal to obtain the desired protection of crops from excess surface and subsurface water. For subsurface drainage, the coefficient is usually expressed as a depth of water to be removed over a safe period of time, usually 24 hours. For surface drainage, the coefficient may be expressed as a

flow rate per unit area. Drainage coefficients are based upon infiltration rates, contributing subsurface flows, and the frequency and depth of rainfall and/or irrigation (fig. 10–30). For systems that utilize subsurface drains to dispose of surface water (underground outlets), the capacity of the system must be based upon both the surface and the subsurface drainage coefficients. A complete discussion of drainage coefficients is found in NEH section 16, chapter 4 and EFH chapter 14.

Drainable porosity is a soil property and is defined as the volume of soil water drained associated with a particular change in water table depth. If the relationship of volume of soil water drained to water table depth is plotted, drainable porosity is the slope of the resulting curve. For most agricultural soils, removal of 0.5 inch of water will cause a shallow water table to drop by about one foot in elevation. At greater depths, the removal of a greater depth of water may be required to lower a water table by one foot.

Figures 10–31a and 10–31b show the relationship of volume drained versus water table depth for several different soils. These curves are specific by soil and can be used in water table management to estimate the water volume that must be removed from an area in order to effect the desired change in water table depth.

Figure 10–30 Determining the apex of the drainage curve for the ellipse equation*

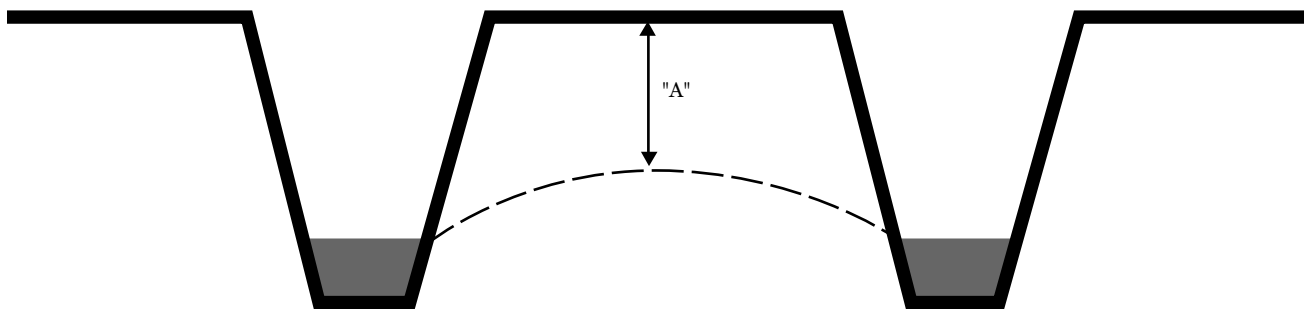

* As a general rule, removal of a 1/2 inch of water has been equated with 12 inches of drawdown ("A") and has been used to estimate drain or ditch spacings required for drainage.

Figure 10-31a Estimating drainable porosity from drawdown curves for 11 benchmark soils (Skaggs 1980)

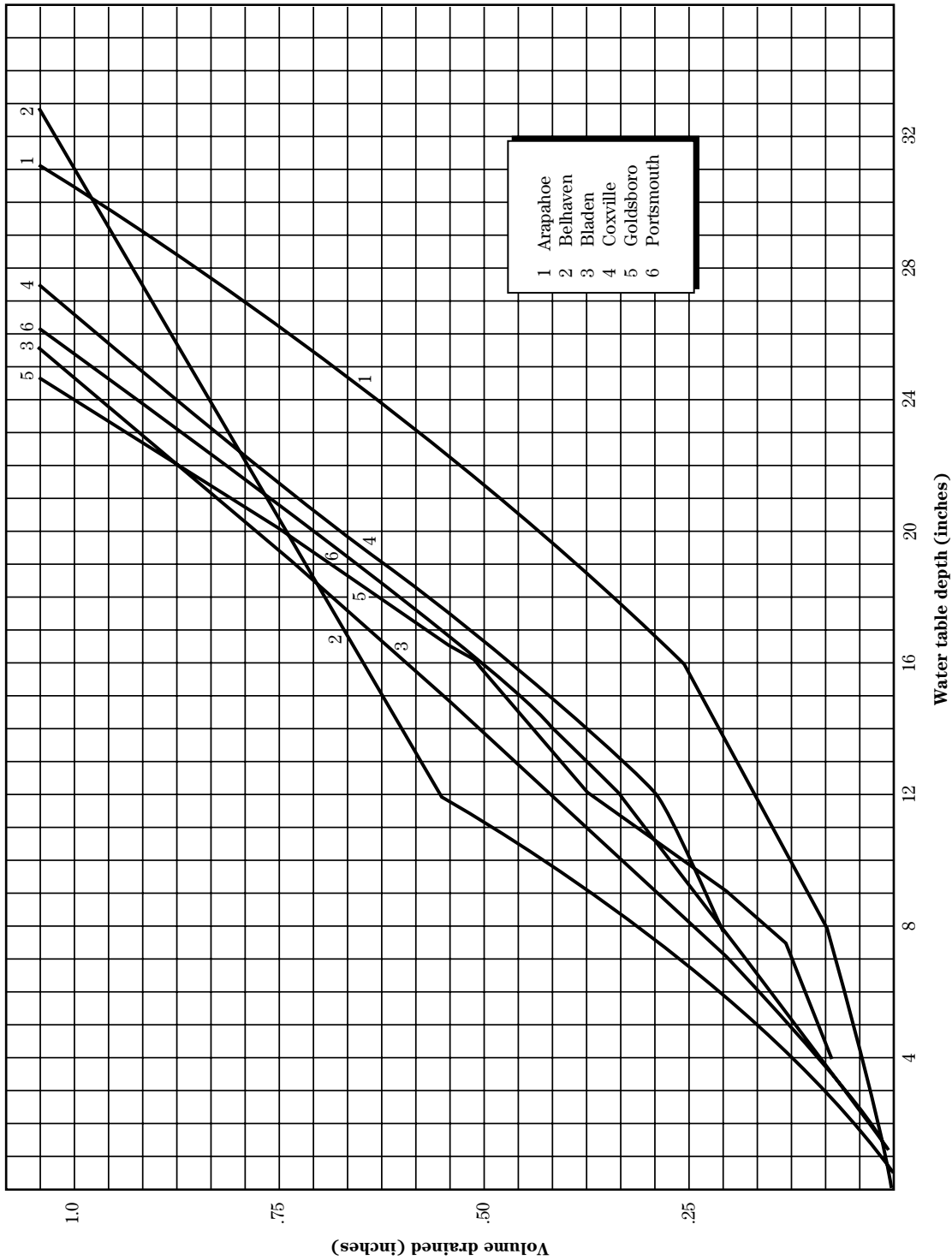
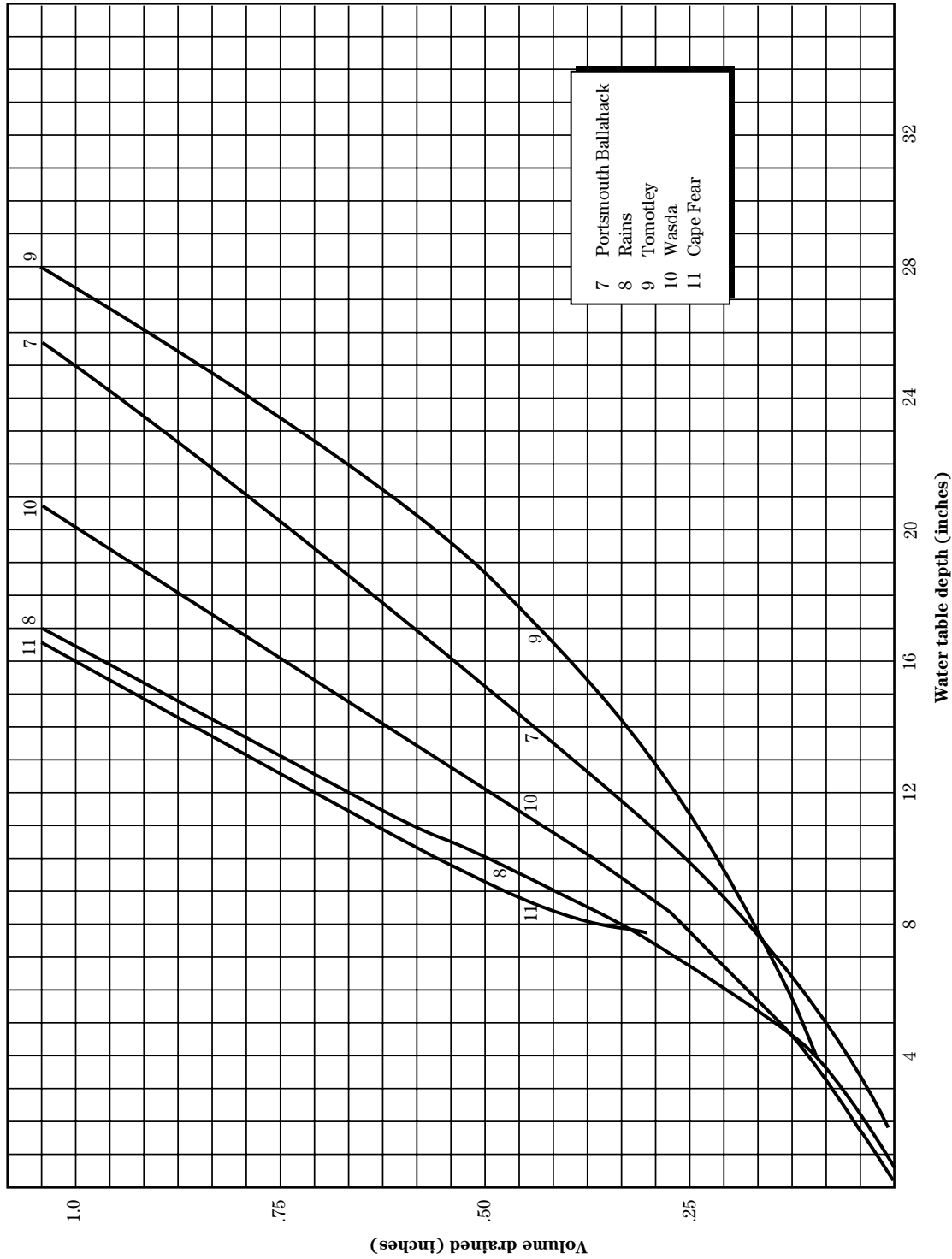

Figure 10-31b Estimating drainable porosity from drawdown curves for 11 benchmark soils (Skaggs 1980)



(2) Allowable sag during subirrigation

The amount of sag that can be tolerated midway between the ditches or subsurface drains and still provide the water needed to meet evapotranspiration demands depends on the soil's ability to transmit water from the water table to the effective root zone, the type of crop and its maturity, and the potential rate of ET. The maximum amount of sag that can be tolerated during subirrigation is determined by the maximum allowable elevation at the ditch, or immediately over the drains, versus the maximum depth tolerable midway between the drain or ditch (fig. 10–32).

Generally, the water table should not be held in the effective root zone of the crop being irrigated. Many crops (corn, soybeans, wheat) have an effective root zone that ranges from 12 to 18 inches below the soil surface. As a result, for these crops the highest elevation that the water table should be held directly above subsurface drain lines or at ditches ranges from 18 to 24 inches beneath the ground surface. Some vegetables exhibit an effective root zone less than 12 inches beneath the soil surface. Extreme caution

should be exercised and more intensive management practiced where the water table is held less than 18 inches beneath the soil surface.

The maximum allowable sag between the drains or ditches can be estimated using the relationship between upward moisture movement versus water table depth. Figure 10–33 is a graph of this relationship for several soils. The depth of the water table that coincides with the selected rate of evapotranspiration can be read for the selected soil. For example, using a peak evapotranspiration rate of 0.25 inch per day on a Goldsboro soil may require the water table to be held approximately 17 inches below the effective root zone of the crop.

In this example, consider corn being grown on a soil, having an average root depth of 24 inches, and being subjected to a peak evapotranspiration rate of 0.25 inch per day. The effective root zone for corn with an average root depth of 24 inches is about 12 inches. Using 12 inches as the effective root zone, the water table should be held no higher than 18 inches beneath

Figure 10–32 Determining the allowable sag of the water table midway between drains or ditches and the tolerable water table elevation above drains or in ditches during subirrigation

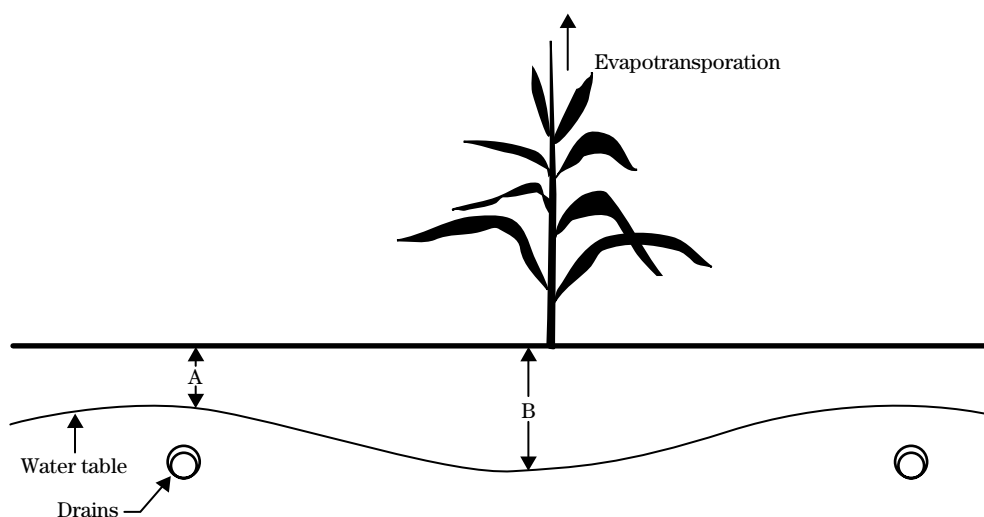

- A Tolerable water table elevation above drains or in ditches. This elevation is dependent on the effective root zone.
- B Allowable sag in the water table midway between the drains or ditches. The allowable sag is dependent upon the soil's ability to transport water from the water table to the effective root zone at the rate that water is being used by the plant during periods of peak evapotranspiration.

Figure 10-33 Estimating water table elevations midway between drains or ditches

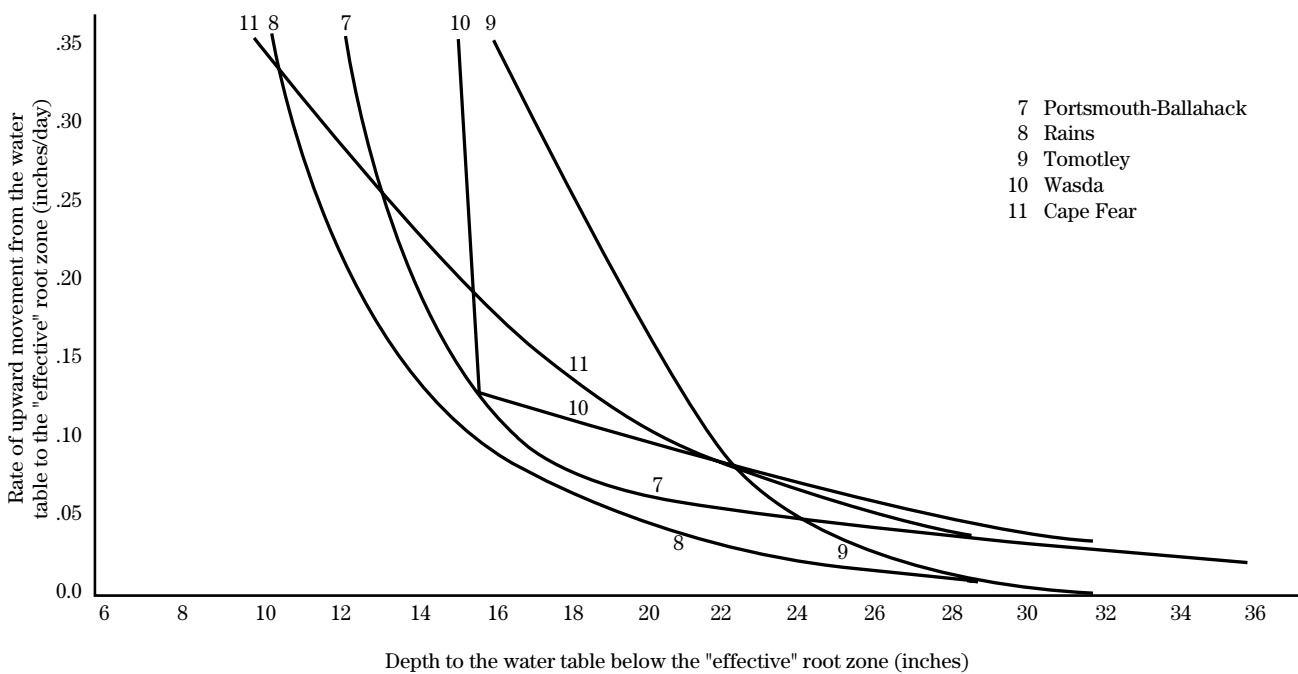
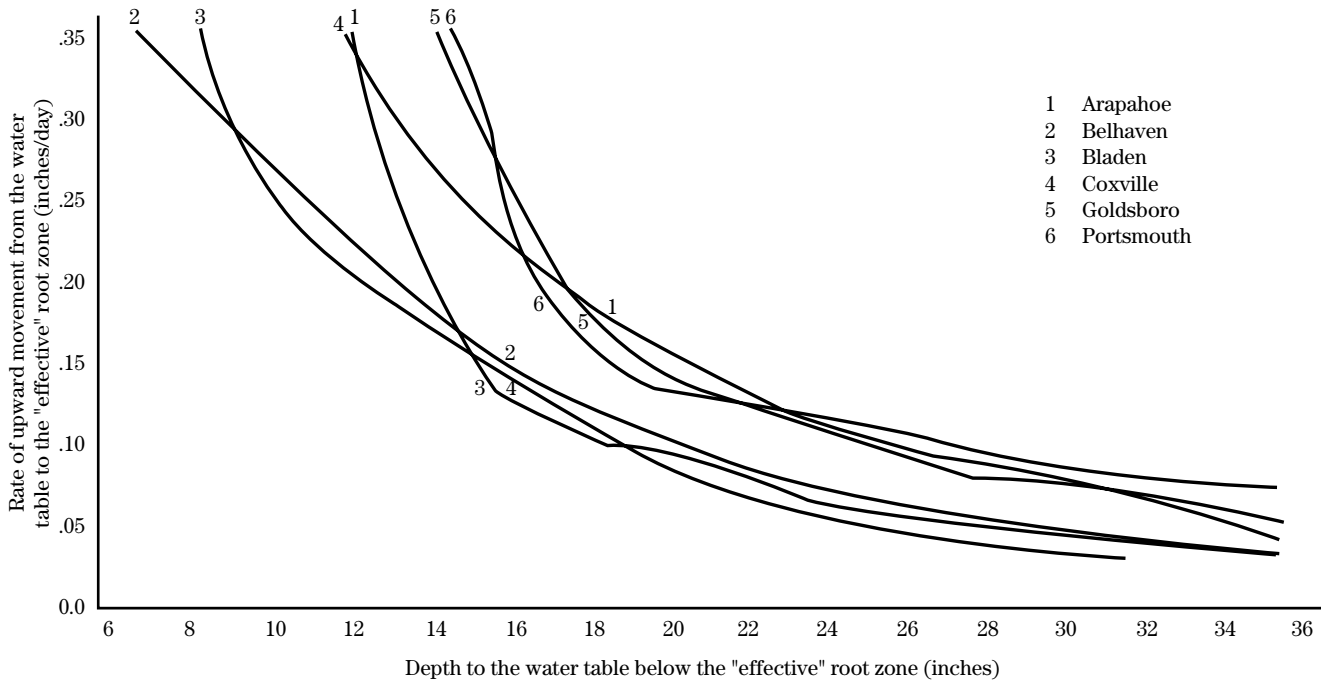

the soil's surface directly above the tile lines, or at the ditches, and no lower than (12 + 17) 29 inches beneath the soil's surface midway between the ditches of drains. Thus, the allowable sag in the water table will be 11 inches.

(d) Design criteria for water table control

Standards for subsurface drain conduits address drain depth, depth of cover, minimum grade and velocity, capacity, size, filter and filter material, envelope and envelope material, and placement. The NRCS Field Office Technical Guide provides these minimum standards. Some of the most frequent deviations from subsurface drain standards and guidelines are described below for subirrigation lines.

(1) Spacing

The spacing required for subirrigation generally is closer than the spacing needed for drainage only. The drain spacings recommended in the drainage guide will not be adequate for subirrigation in most cases; therefore, the spacing for subirrigation should be determined by one of the methods shown in section 624.1004(e).

(2) Size

Since the spacing for subirrigation is closer than that used for drainage, smaller conduits can usually be used. Unless the lines are extremely long, 4-inch diameter tubing is generally adequate for subirrigation. The actual size necessary to carry the minimum design capacity is a function of both spacing and length. The minimum capacity should be equal to a drainage coefficient of 0.5 inch per day. If a higher drainage coefficient is needed, the tubing should be sized accordingly. Usually, the length of each line of tubing is the limiting factor that must be adjusted if the drainage coefficient is exceeded because it is not practical to adjust the spacing. Use the formula 10-4 to determine the length and spacing of the tubing needed to meet the drainage coefficient requirement.

[10-4]

$$\text{Drainage coefficient (in / d)} = \frac{Q(\text{ft}^3 / \text{s}) \times 1,036,800}{\text{Length (ft)} \times \text{spacing (ft)}}$$

Example: Using 4-inch tubing

Given: Tubing on 0.1 percent grade
 Length of longest line = 1,000 ft
 Spacing = 80 ft
 Q, from figure 10-33 = .053 ft³/s
 Minimum drainage coefficient = 0.5 in/d

Note: The solution will be inches per day.

$$\begin{aligned} \text{actual drainage coefficient} &= \frac{.053 \text{ ft}^3 / \text{s} \times 1,036,800}{1,000 \text{ ft} \times 80 \text{ ft}} \\ &= \frac{54,950.4}{80,000} \\ &= 0.69 \text{ in / d} \end{aligned}$$

Using this drain spacing and having the longest line 1,000 feet in length assures that more than 0.5 inch per day could be removed, based on the tubing capacity. If the computed drainage coefficient does not equal or exceed 0.5 inch per day, the length of line should be shortened (fig. 10-34).

(3) Grade

Where possible, tubing should be installed on grade as recommended in the NRCS Practice Standard 606, Subsurface Drain. In some cases this is not practical because of the length of lines, required cover, and location of impermeable layers in the soil.

Drains should have sufficient capacity to remove excess water from minor surface depressions and from the major part of the root zone within 24 to 48 hours after rain ceases. The required amount of water to be removed is the drainage coefficient and, for subsurface drainage, is expressed as inches of water depth to be removed over a safe period of time, usually 24 hours, or as an inflow rate per unit of drain. Because of the differences in soil conductivity, climate, and crops, as well as the manner in which water may enter the drain (all from subsurface flow or part from subsurface flow and part from surface inlets), the coefficient must be modified to fit site conditions in accordance with a local drainage guide.

Figure 10-34 Plastic tubing drainage chart

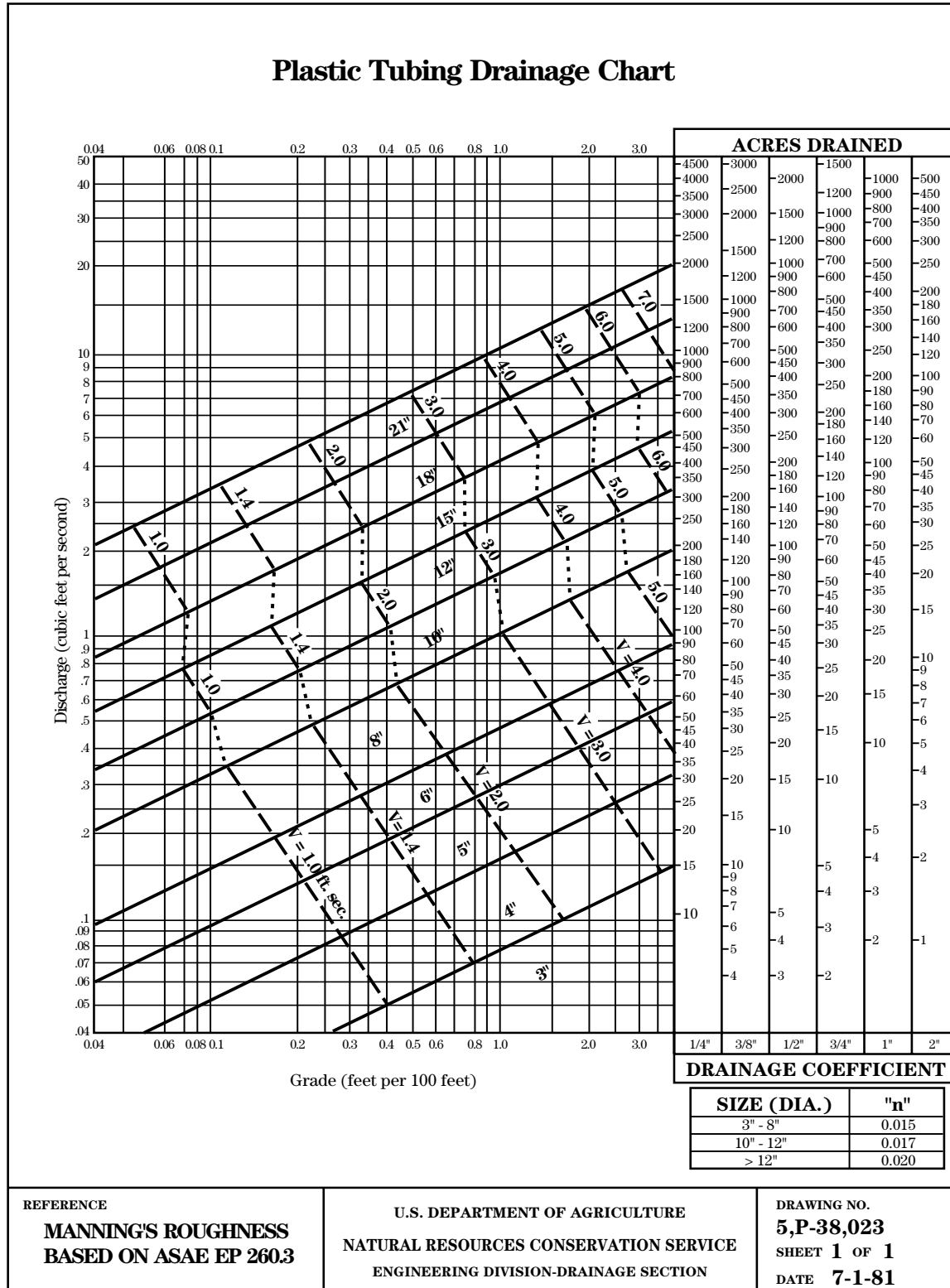

Tubing for subirrigation has been installed at grades less than 0.10 foot per 100 feet, and in some cases absolutely flat. This tubing appears to be functioning satisfactorily, however, these systems have been installed for only a few years and may develop problems later. Whenever tubing is installed below minimum grade, extreme caution should be exercised to thoroughly evaluate the need for filters (fig. 10–35).

Figure 10–35 Situation where it is not practical to satisfy minimum recommended cover and grade

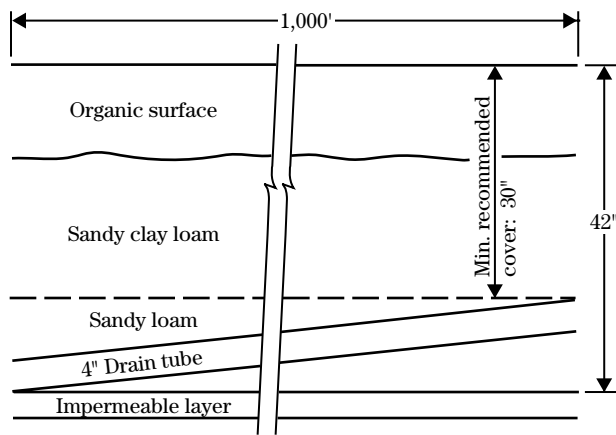

Desired drain length	1,000 feet
Minimum recommended cover	30 inches
Do not install tubing below impermeable layer; therefore, maximum tubing depth	42 inches
Recommended grade for 4-inch tubing	0.15 foot per 100 feet

$$\begin{aligned} \text{Available head} &= 42 \text{ in} - (30 \text{ in} + 4 \text{ in}) \\ &= 8 \text{ in} \left(\frac{1 \text{ ft}}{12 \text{ in}} \right) = 0.67 \text{ ft} \end{aligned}$$

Actual grade [0.67 ft/1,000 ft]	0.06 foot per 100 feet
---------------------------------	------------------------

(e) Estimating tubing and ditch spacings

During the initial planning process, estimates are needed for the spacing of ditches or tubing to meet subsurface drainage and subirrigation requirements. In most cases, existing drainage systems must be evaluated to determine their potential performance for controlled drainage or subirrigation. The estimates must be accurate enough for the landowner to establish goals and make a commitment of time and money. When a decision is made based on these estimates, a detailed evaluation is justified. When a system is designed using the computer model DRAINMOD, these spacing estimates may be used as the input spacings for initial computer simulations to begin fine tuning the design.

The ellipse equation can be used to determine the spacing of relief type drains for drainage and subirrigation. Three variations of this equation are used, depending on the mode of operation (fig. 10–36, 10–37, and 10–38). Equations 10–5 and 10–8 are the ellipse equations, while equations 10–6 and 10–9 are the Hooghoudt modification of the ellipse equation. Hooghoudt's modification accounts for the head loss in the ground water system as flows converge to a subsurface drain. Hooghoudt's modification substitutes equivalent distance, d_e , in place of d for the distance from the bottom of the drain tubing to the impermeable layer. For a complete explanation of the ellipse equation and a definition of the factors used in the formula, refer to NRCS National Engineering Handbook, Section 16, Drainage of Agricultural Land, Chapter 4.

To estimate ditch or tubing spacing, at least two possible conditions need to be evaluated:

- Estimate the spacing necessary to provide drainage when the system is operated in either the controlled drainage or subirrigation mode.
- Estimate the spacing necessary to provide subirrigation.

The closer spacing would represent the most limiting condition and would provide the best estimate to use to prepare the initial cost estimate.

Examples 10–1, 10–2, 10–3, and 10–4 use the ellipse equation to estimate ditch or tubing spacing for either controlled drainage or subirrigation.

Figure 10-36 Estimating ditch or tubing spacing for drainage only using the ellipse equation

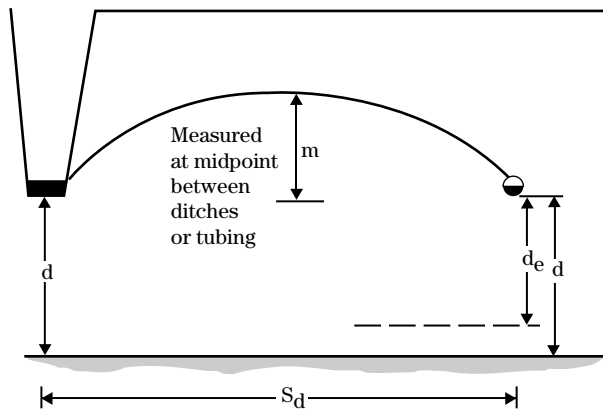

**Ellipse equation
Ditches [eq. 10-5]**

$$S_d = \left[\frac{4K_e m (2d + m)}{q} \right]^{\frac{1}{2}}$$

**Hooghoudt equation
Drain tubing [eq. 10-6]**

$$S_d = \left[\frac{4K_e m (2d_e + m)}{q} \right]^{\frac{1}{2}}$$

where:

- S_d = ditch or drain spacing needed for drainage, ft
- K_e = equivalent lateral hydraulic conductivity, in/hr
- m = height of water table above ditch or drain (gradient), ft
- d = distance from bottom of ditch or tubing to impermeable layer, ft
- q = required drainage coefficient, in/hr
- d_e = equivalent distance from bottom of tubing to impermeable layer, ft

where:

$$d_e = \frac{d}{1 + \frac{d}{S_d} \left[\frac{8}{\pi} \text{Ln} \left(\frac{d}{r_e} \right) - 3.4 \right]} \quad [10-7]$$

r_e is from table 10-1. The effective radius is considerably smaller than the actual drain tube radius to account for the resistance to inflow due to a finite number of openings in the drain tube wall.

Figure 10-37 Estimating ditch or tubing spacing for subirrigation using the ellipse equation

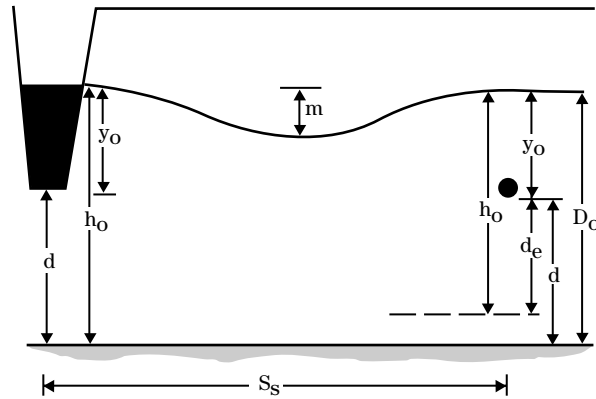

Ditches [eq. 10-8]

$$S_s = \left[\frac{4K_e m (2h_o + m)}{q} \right]^{\frac{1}{2}}$$

where: $h_o = d + y_o$

Tubing [eq. 10-9]

$$S_s = \left[\frac{4K_e m \left(2h_o - h_o \frac{m}{D_o} \right)}{q} \right]^{\frac{1}{2}}$$

where: $h_o = d_e + y_o$
 $D_o = d + y_o$

where:

- S_s = ditch or tubing spacing needed for subirrigation, ft
- K_e = equivalent hydraulic conductivity, in/hr
- m = the difference between the water table level midway between the drains and the water table directly over the drain, (gradient), ft
- d = distance from bottom of ditch or tubing to impermeable layer (ft)
- q = required drainage coefficient, in/hr
- y_o = distance from water table directly over the drain to the bottom of the ditch or tubing, ft
- d_e = equivalent distance from bottom of tubing to impermeable layer, ft

where:

$$d_e = \frac{d}{1 + \frac{d}{S_d} \left[\frac{8}{\pi} \text{Ln} \left(\frac{d}{r_e} \right) - 3.4 \right]} \quad [\text{using eq. 10-7}]$$

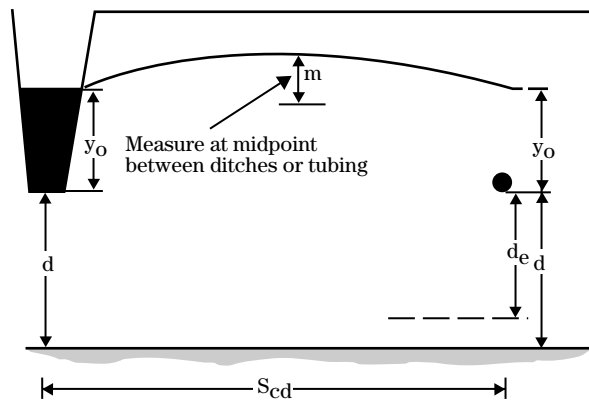
Figure 10-38 Use of ellipse equation to estimate ditch or tubing spacing for controlled drainage**Ditches [eq. 10-10]**

$$S_{cd} = \left[\frac{4K_e m (2h_o + m)}{q} \right]^{\frac{1}{2}}$$

where: $h_o = d + y_o$

Drain Tubing [eq. 10-11]

$$S_{cd} = \left[\frac{4K_e m (2h_o + m)}{q} \right]^{\frac{1}{2}}$$

where: $h_o = d_e + y_o$

where:

S_{cd} = ditch or drain spacing needed for controlled drainage, ft

K_e = equivalent hydraulic conductivity, in/hr

m = height of water table above ditch or tubing (gradient), ft

d = distance from bottom of ditch or tubing to impermeable layer, ft

q = required drainage coefficient, in/hr

d_e = equivalent distance from bottom of tubing to impermeable layer, ft

where:

$$d_e = \frac{d}{1 + \frac{d}{S_d} \left[\frac{8}{\pi} \text{Ln} \left(\frac{d}{r_e} \right) - 3.4 \right]} \quad [\text{using eq. 10-7}]$$

Note: When y_o is zero, these equations are the same as equations 10-5 and 10-6.

Table 10-1a Effective radii for various size drain tubes (Skaggs, 1980)

Drain	r_e (feet)
3-in corrugated	0.012
4-in corrugated	0.017
4-in corrugated with synthetic filter	0.033
5-in corrugated	0.033
6-in corrugated	0.48
4-in clay - 1/16" crack between joints	0.010
4-in clay - 1/8" crack between joints	0.016

Table 10-1b Effective radii for open ditches and drains with gravel envelopes

Drain type	r_e (ft)
Drain tube with gravel envelope*	1.177n
Ditch, any size	1.0

* Assumes gravel envelope with a square cross-section of length 2n on each side.

Source: USDA-NRCS, Hydrology Tools for Wetland Determination Workbook, 1998

Example 10-1 Ditch spacing for controlled drainage

Determine: Ditch spacing needed to provide drainage for the situation shown in figure 10-39.

Assume: Goldsboro soil and corn with a maximum root depth of 24 inches will be grown.

Solution: **Step 1: Determine the required drawdown in 24 hours.** Since the maximum root depth is 24 inches, the effective root depth is 12 inches. Therefore, the required drawdown would be 12 inches in 24 hours.

Step 2: Determine the drainage coefficient needed to provide 12 inches of draw-down. From figure 10-31a, we see that to lower the water table 12 inches in a Goldsboro soil requires a volume drained of 0.33 inches:

$$\frac{0.33 \text{ in} / d}{24 \text{ hr} / d} = 0.0139 \text{ in} / \text{hr} \quad [10-12]$$

Step 3: Determine the equivalent hydraulic conductivity (K_e) to use in the ellipse equation. Notice that only 2 inches of the surface layer was used because as the water table drops from the surface, saturated flow is not occurring in the entire layer (refer to fig. 10-22 and 10-39).

$$K_e = \frac{(2 \text{ in} \times 3.5 \text{ in} / \text{hr}) + (34 \times 1.2 \text{ in} / \text{hr}) + (36 \text{ in} \times 1.5 \text{ in} / \text{hr})}{2 \text{ in} + 34 \text{ in} + 36 \text{ in}} \quad [10-13]$$

$$K_e = 1.41 \text{ in} / \text{hr}$$

Step 4: Determine the gradient m . From figure 10-39, we see that the water table in the ditch is being controlled at 24 inches and the desired drawdown is 12 inches, thus:

$$m = 24 \text{ in} - 12 \text{ in} \\ = 12 \text{ in}$$

Step 5: Determine the ditch spacing needed to provide drainage during controlled drainage from equation 10-10.

$$S_{cd} = \left[\frac{4K_e m (2h_o + m)}{q} \right]^{\frac{1}{2}}$$

$$S_{cd} = \left[\frac{4(1.41 \text{ in} / \text{hr})(1 \text{ ft.})[2(5 \text{ ft}) + 1 \text{ ft.}]}{0.0139 \text{ in} / \text{hr}} \right]^{\frac{1}{2}}$$

$$S_{cd} = 67.0 \text{ ft}$$

The estimated ditch spacing needed to provide the required drainage during the controlled drainage mode is 67 feet.

Example 10-1 Ditch spacing for controlled drainage—Continued

Figure 10-39 Determining the ditch spacing needed for controlled drainage

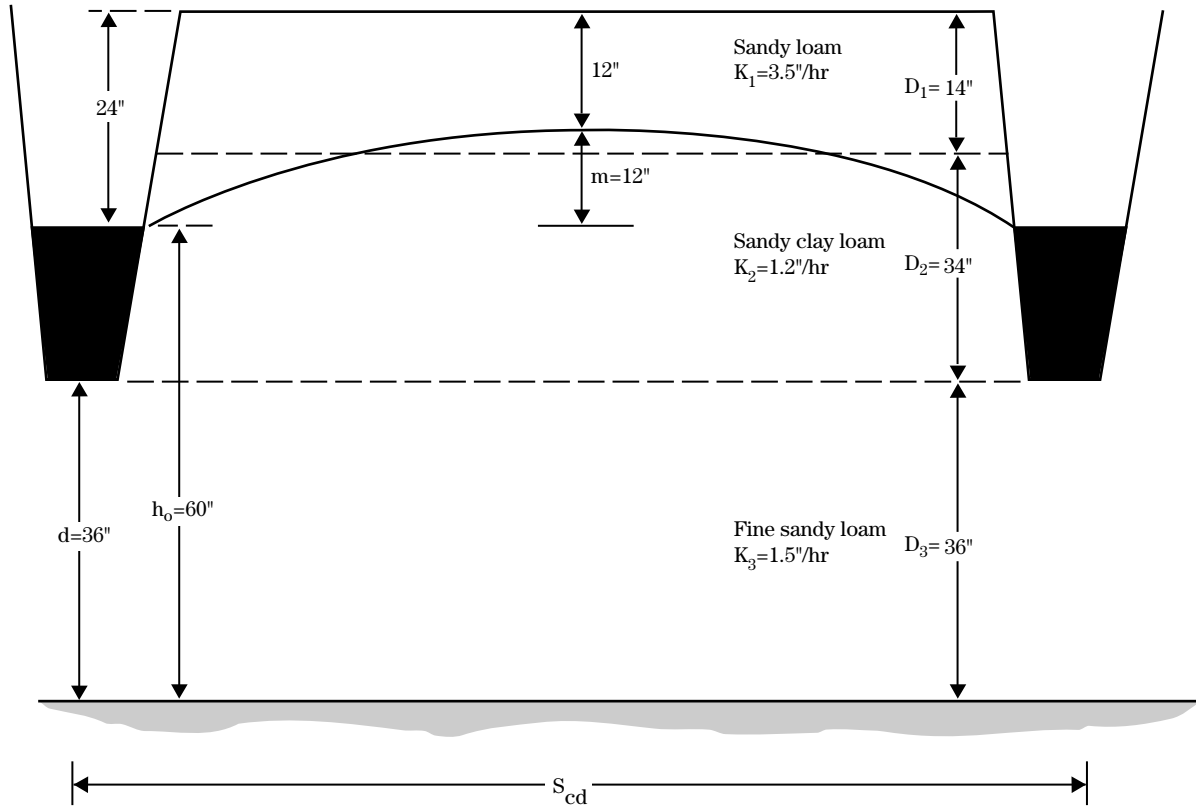

Example 10-2 Ditch spacing necessary to provide subirrigation

Determine: The ditch spacing necessary to provide subirrigation in the same field as example 10-1 (fig. 10-40).

Assume: The peak evapotranspiration rate for corn is 0.25 inch per day.

Figure 10-40 Determining the ditch spacing for subirrigation

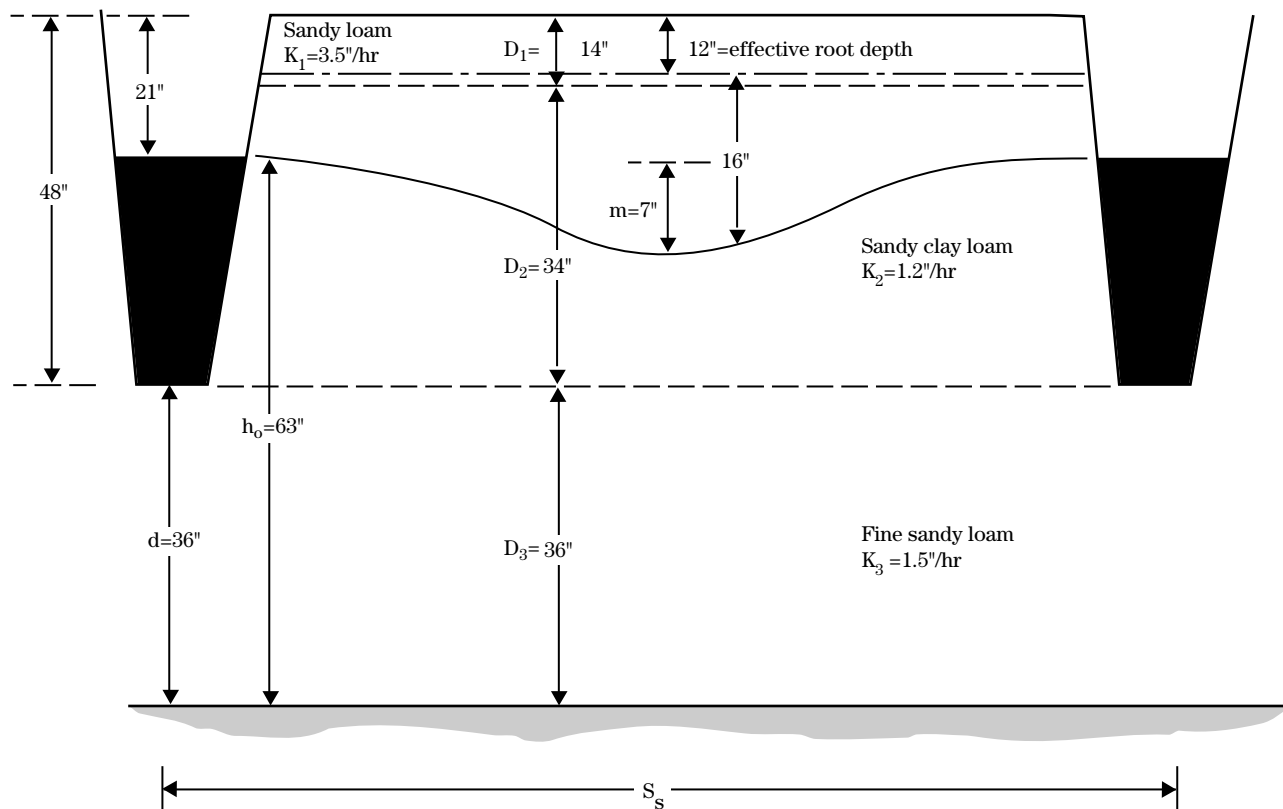

Solution: **Step 1: Determine the maximum allowable water table elevation in the ditch.** As in the previous example, the effective root depth is 12 inches. At least a 6-inch safety zone is required, but a 9- to 12-inch root zone is preferred. In this example use 9 inches. Therefore, the maximum water table elevation in the ditch is 21 inches below the surface.

Step 2: Determine the lowest allowable water table elevation at midpoint. From figure 10-33, the water table depth below the effective root depth to supply 0.25 inch per day for a Goldsboro soil is approximately 16 inches. The distance from the surface to the lowest allowable water table level is then:

$$16 + 12 = 28 \text{ inches}$$

Example 10-2 Ditch spacing necessary to provide subirrigation—Continued**Step 3: Determine the allowable sag:**

$$28 - 21 = 7 \text{ inches}$$

$$\text{Sag} = 0.58 \text{ foot}$$

The sag is equivalent to the gradient, m .

Step 4: Determine the equivalent hydraulic conductivity. Assume all flow occurs below the lowest water table elevation. This means that flow occurs in 20 inches of layer 2 and all of layer 3.

$$K_e = \frac{(20 \text{ in} \times 1.2 \text{ in / hr}) + (36 \times 1.5 \text{ in / hr})}{20 \text{ in} + 36 \text{ in}} \quad [\text{using eq. 10-13}]$$

$$= 1.39 \text{ in / hr}$$

Notice that since the water table is 28 inches deep at the lowest point, no flow occurs in layer 1 and in the upper 14 inches of layer 2.

Step 5: Determine h_o to be used in equation 10-8. Since the water table depth at the ditch is 21 inches below the surface;

$$h_o = 7 \text{ ft} - 21 \text{ in}$$

$$= 7 \text{ ft} - 1.75 \text{ ft}$$

$$= 5.25 \text{ ft}$$

Step 6: Determine the ditch spacing required to provide subirrigation using equation 10-8. The value for q during subirrigation is the ET rate that was 0.25 inch per day or 0.0104 inch per hour.

$$K_e = \frac{K_2 D_2 + K_3 D_3}{D_2 + D_3}$$

$$K_e = \frac{1.2 \text{ in / hr}(63 \text{ in} - 36 \text{ in}) + 1.5 \text{ in / hr}(36 \text{ in})}{63}$$

$$K_e = 1.37 \text{ in / hr}$$

$$S_s = \left[\frac{4K_e m (2h_o - m)}{q} \right]^{\frac{1}{2}}$$

$$S_s = \left\{ \frac{4[1.39 \text{ in / hr}][.58 \text{ ft}][2(5.25 \text{ ft}) - .58 \text{ ft}]}{.0104 \text{ in / hr}} \right\}^{\frac{1}{2}}$$

$$S_s = 55.1 \text{ ft}$$

The ditch spacing (55.1 ft) required for subirrigation is less than the spacing (67 ft) required for controlled drainage. Therefore, the closer spacing should be used to estimate the cost of the system.

Example 10-3 Tubing spacing for controlled drainage

Determine: Drain tubing spacing needed to provide drainage for the situation shown in figure 10-41.

Assume: Goldsboro soil and corn with a maximum rooting depth of 24 inches will be grown.

Figure 10-41 Determining the tubing spacing for controlled drainage

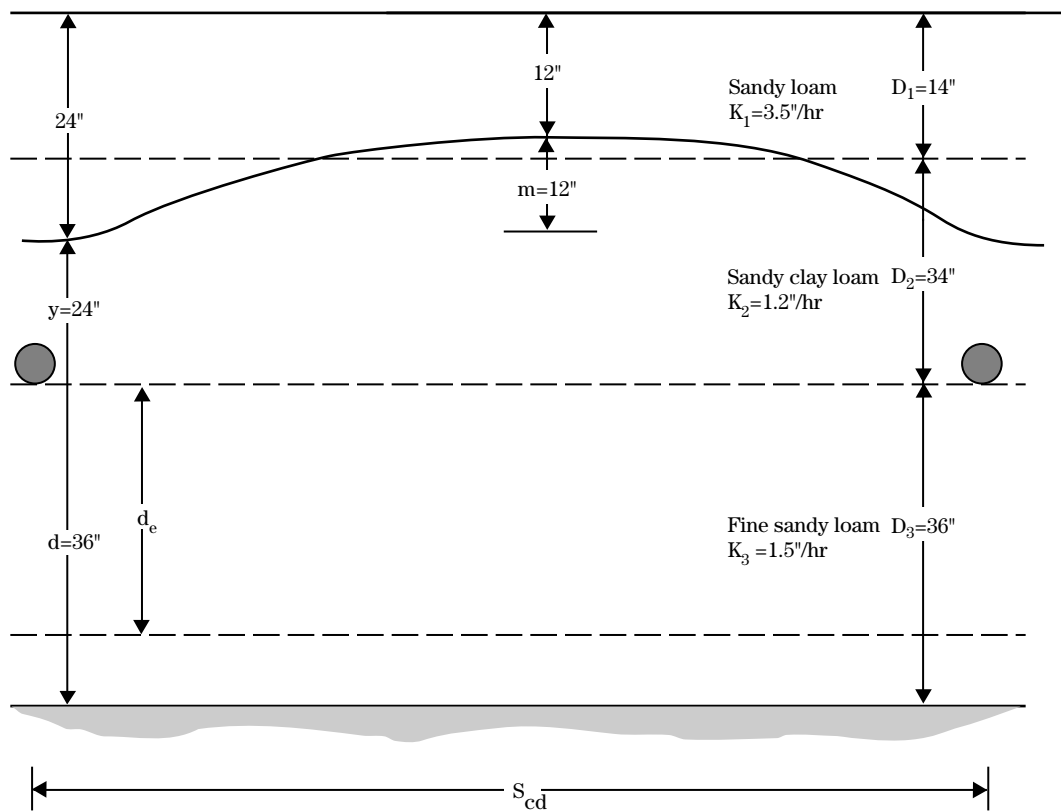

Solution: **Step 1: Determine the required drawdown in 24 hours.** Since the maximum root depth is 24 inches, the effective root depth is 12 inches. Therefore, the required drawdown would be 12 inches in 24 hours.

Step 2: Determine the drainage coefficient needed to provide 12 inches of draw-down. From figure 10-31a, we see that to lower the water table 12 inches, a Goldsboro soil requires a volume drained of 0.33 inch, which is:

$$\frac{0.33 \text{ in}}{24 \text{ hr}} = 0.0139 \text{ in / hr}$$

Example 10-3 Tubing spacing for controlled drainage—Continued

Step 3: Determine the equivalent hydraulic conductivity (K_e) to use in the ellipse equation. Notice that only 2 inches of the surface layer was used because as the water table drops from the surface, flow is not occurring in the entire layer.

$$K_e = \frac{(2 \text{ in} \times 3.5 \text{ in/hr}) + (34 \times 1.2 \text{ in/hr}) + (36 \text{ in} \times 1.5 \text{ in/hr})}{2 \text{ in} + 34 \text{ in} + 36 \text{ in}}$$

$$K_e = 1.41 \text{ in/hr}$$

Step 4: Determine the gradient m . From figure 10-41, we see that the water table in the tubing is being controlled at 24 inches, and the desired drawdown is 12 inches, thus:

$$m = 24 \text{ inches} - 12 \text{ inches}$$

$$= 12 \text{ inches}$$

Step 5: Determine the first estimate of the tubing spacing needed to provide drainage during controlled drainage from equation 10-11. With drain tubing, we must account for convergence near the drain tube. This is done by determining depth to the impermeable layer, d_e , to be used in the ellipse equation. Unfortunately, d_e depends on the drain spacing, so we have to solve the ellipse equation for S and the Hooghoudt equation for d_e by trial and error. For the first estimate, use a value of d_e equal to d . Calculate S_{cd} by using equation 10-11:

$$S_{cd} = \left[\frac{4K_e m (2h_o + m)}{q} \right]^{\frac{1}{2}}$$

$$S_{cd} = \left[\frac{4(1.41 \text{ in/hr})(1 \text{ ft.})[2(5 \text{ ft}) + 1 \text{ ft}]}{0.0139 \text{ in/hr}} \right]^{\frac{1}{2}}$$

$$S_{cd} = 67.0 \text{ ft}$$

Where $h_o = d_e + y_o$

$$S_{cd} = \left[\frac{4(1.41 \text{ in/hr})(1.0 \text{ ft.})[2(3 \text{ ft.} + 2 \text{ ft}) + 1 \text{ ft}]}{0.0139 \text{ in/hr}} \right]^{\frac{1}{2}}$$

$$S_{cd} = 66.8 \text{ ft}$$

Example 10-3 Tubing spacing for controlled drainage—Continued

Step 6: Determine a value of d_e using Hooghoudt's equation and the value of S_{cd} just determined. For $S_{cd} = 65.2$ feet.

$$d_e = \frac{d}{1 + \frac{d}{S_d} \left(\frac{8}{\pi} \right) \text{Ln} \left(\frac{d}{r_e} - 3.4 \right)}$$

$$d_e = \frac{3}{1 + \frac{3 \text{ ft}}{65.2 \text{ ft}} \left[\frac{8}{\pi} \text{Ln} \left(\frac{3 \text{ ft}}{.017 \text{ ft}} \right) - 3.4 \right]} \quad \text{[using eq. 10-7]}$$

$$= 2.09 \text{ ft}$$

Using 4 in. tubing where $r_e = .017$ ft

Step 7: Recalculate S_{cd} (2nd try) using the value of d_e determined in Step 6.

Again, using equation 10-11 and $d_e + Y_o = 2.07$ feet:

$$S_{cd} = \left[\frac{4 \left[1.41 \text{ in / hr} \right] \left[1.0 \text{ ft.} \right] \left[2(2.09 \text{ ft.} + 2 \text{ ft}) + 1 \text{ ft} \right]}{0.0139 \text{ in / hr}} \right]^{\frac{1}{2}}$$

$$S_{cd} = 61 \text{ ft}$$

Step 8: Since the second calculation of S_{cd} of 59.4 feet is more than 1 foot more (or less) than S_{cd} on trial 1, recalculate d_e using the latest value of S_{cd} .

$$d_e = \frac{3}{1 + \frac{3}{61} \left[\frac{8}{\pi} \text{Ln} \left(\frac{3}{.017} \right) - 3.4 \right]}$$

$$= 2.03 \text{ ft}$$

Step 9: Recalculate S_{cd} (3rd try) using $d_e=2.03$ feet:

$$S_{cd} = \left[\frac{4(1.41 \text{ in / hr})(1 \text{ ft.})[2(2.03 \text{ ft.} + 2 \text{ ft}) + 1 \text{ ft}]}{0.0139 \text{ in / hr}} \right]^{\frac{1}{2}}$$

$$S_{cd} = 60.6 \text{ ft}$$

Since the value 60.6 feet is only 0.2 foot less than the previous value, it is not necessary to repeat the process again. So the estimated design spacing for drain tubing for this system being operated in the control drainage mode is 61 feet. Notice that this is less than the ditch spacing of 67 feet needed for the same operation. This is because of the convergence that occurs with drain tubing.

Example 10-4 Drain tubing for subirrigation

Determine: Drain tubing spacing necessary to provide subirrigation in the same field as that in example 10-3. Refer to figure 10-42.

Assume: Peak evapotranspiration rate for corn is 0.25 inch per day. This is basically the same problem as that in example 10-2 except drain tubing is being used rather than ditches

Figure 10-42 Determining the tubing spacing for subirrigation

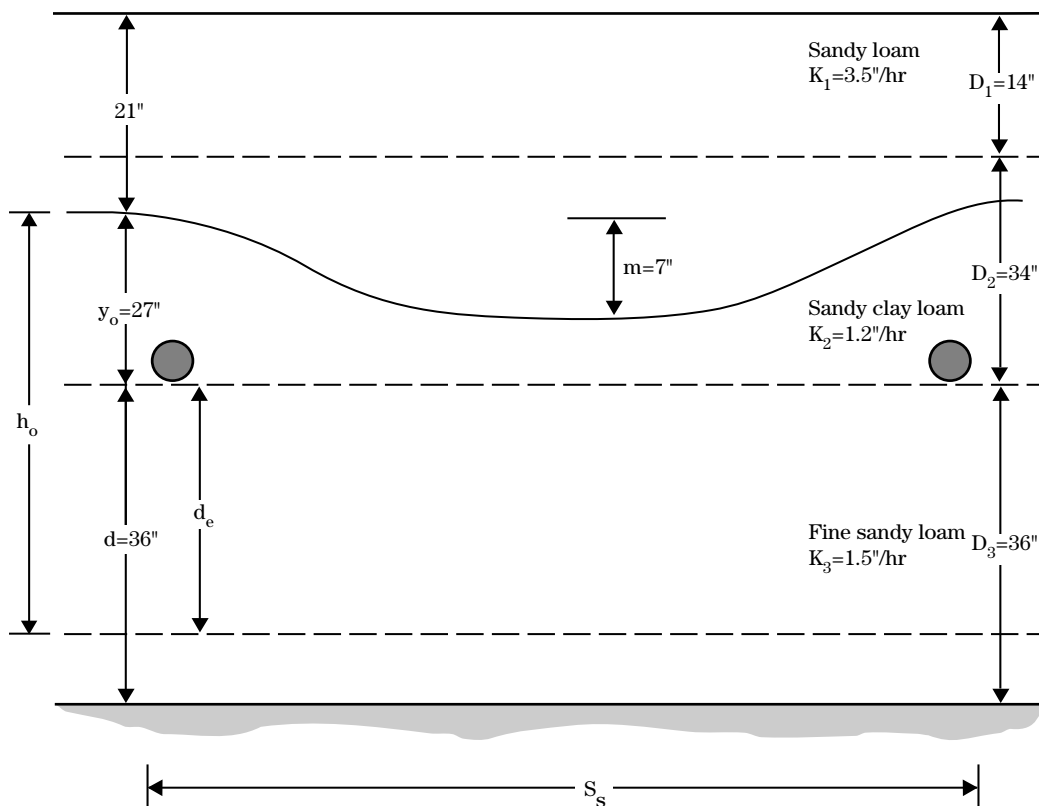

Solution: **Step 1: Determine the maximum allowable water table elevation above the drain tubing.** As in the previous example, the effective root depth is 12 inches. At least a 6-inch safety zone is required, but a 9- to 12-inch zone is preferred. In this example, use 9 inches. Therefore, the maximum water table elevation directly above the tubing is 21 inches below the surface.

Example 10-4 Drain tubing for subirrigation—Continued

Step 2: Determine the lowest allowable water table elevation at the midpoint between drain lines. From figure 10-33, the water table depth below the effective root depth to supply 0.25 inch per day for a Goldsboro soil is approximately 16 inches. The distance from the surface to the lowest allowable water table level is:

$$16 + 12 = 28 \text{ inches}$$

Step 3: Determine the allowable sag: 28 in–21 in = 7 in, or 0.58 ft. The sag is equivalent to the gradient m .

Step 4: Determine the equivalent hydraulic conductivity. Assume all flow occurs below the lowest water table elevation. This means that flow occurs in 20 inches of layer 2 and all of layer 3. Saturated depth of layer 2 = 63 in–36 in–7 in = 20 in.

$$K_e = \frac{(20 \text{ in} \times 1.2 \text{ in / hr}) + (36 \times 1.5 \text{ in / hr})}{20 \text{ in} + 36 \text{ in}}$$

$$= 1.39 \text{ in / hr}$$

Notice that since the water table is 28 inches deep at the lowest point, no flow occurs in layer 1 and in the upper 14 inches of layer 2.

Step 5: Determine h_o to be used in equation 10-9. $h_o = d_e + y_o$ is not known until Hooghoudt's equation has been solved, so use d , which is 3 feet, for the first try. y_o is the height of the water level over the tubing. The water level is to be held 21 inches (1.75 feet) below the surface over the tubing and the tubing is 4 feet below the surface, thus the first estimate is:

$$4 \text{ ft} - 1.75 \text{ ft} = 2.25 \text{ ft}$$

$$h_o = 3 \text{ ft} + 2.25 \text{ ft} = 5.25 \text{ ft}$$

Step 6: Determine the D_o to be used in equation 10-9. $D_o = d + y_o$. D_o is the distance from the drain tubing to the barrier. As seen in figure 10-41:

$$d = 3 \text{ ft}$$

$$y_o = 2.25 \text{ ft (the same as that in step 5)}$$

$$D_o = 3 + 2.25 = 5.25 \text{ ft (the first try and all other iterations of this equation).}$$

Step 7: Determine the tubing spacing required to provide subirrigation using equation 10-9. The value of q during subirrigation is the ET rate, which in this example was 0.25 inch per day, or 0.0104 inch per hour.

Example 10-4 Drain tubing for subirrigation—Continued

$$S_s = \left[\frac{4K_e m \left(2h_o - h_o \frac{m}{D_o} \right)}{q} \right]^{\frac{1}{2}}$$

$$= \left\{ \frac{4 \left[1.39 \text{ in / hr} \right] \left[0.58 \text{ ft} \right] \left[2(5.25 \text{ ft}) - 5.25 \text{ ft} \frac{0.58 \text{ ft}}{5.25 \text{ ft}} \right]}{0.0104 \text{ in / hr}} \right\}^{\frac{1}{2}}$$

$$= 55.5 \text{ ft}$$

Where:

$$h_o = d_e + y_o$$

$$D_o = d + y_o$$

Step 8: Determine a value for d_e using Hooghoudt's equation and the value of S_s just determined. For $S_s = 55.5$ feet

$$d_e = \frac{d}{1 + \frac{d}{S} \left[\frac{8}{\pi} \ln \left(\frac{d}{r_e} \right) - 3.4 \right]}$$

$$= \frac{3 \text{ ft}}{1 + \frac{3 \text{ ft}}{55.5 \text{ ft}} \left[2.55 \ln \left(\frac{3 \text{ ft}}{.017 \text{ ft}} \right) - 3.4 \right]}$$

$$= 1.96 \text{ ft}$$

r_e from table 10-1 = 0.017 ft

Step 9: Recalculation of S_s (2nd trial) using $d_e=1.96$ feet.

$$S_s = \left\{ \frac{4 \left[1.39 \text{ in / hr} \right] \left[0.58 \text{ ft} \right] \left[2(1.96 + 2.25) - (1.96 + 2.25) \left(\frac{0.58 \text{ ft}}{5.25 \text{ ft}} \right) \right]}{0.0104} \right\}^{\frac{1}{2}}$$

$$S_s = 49.7 \text{ ft}$$

Step 10: Recalculate d_e using $S_s=49.7$ feet.

$$d_e = \frac{3}{1 + \frac{3}{49.7} \left[2.55 \ln \left(\frac{3}{.017} \right) - 3.4 \right]}$$

$$= 1.89 \text{ ft}$$

Example 10-4 Drain tubing for subirrigation—Continued**Step 11: Recalculate S_s using $d_e=1.89$ feet.**

$$S_s = \left\{ \frac{4[1.39 \text{ in / hr}][.58 \text{ ft}][2(1.89 \text{ ft} + 2.25 \text{ ft}) - [1.89 + 2.25]\left[\frac{0.58}{5.25}\right]]}{0.0104} \right\}^{\frac{1}{2}}$$

$$= 49.3 \text{ ft}$$

Since this value 49.3 feet is less than a 1-foot difference from the previous step, use this value as the estimated design drain spacing. Again, this tube spacing of 49.3 feet is less than the ditch spacing of 55.1 feet (example 10-2) because of flow convergence that occurs around drain tubes.

(f) Placement of drains and filter requirements

(1) Placement with respect to the soil profile

The performance of tubing or ditches used in a subirrigation system will be affected by their placement in the soil profile with respect to the arrangement of the soil horizons. When the placement of tubing or ditches is not controlled by the elevation of the outlet, careful consideration should be given to the arrangement of the soil horizons.

In some cases water movement during subirrigation and the rate of water table rise are not dependent on the depth of tubing. Careful consideration should be given to the placement of tubing and the depth of ditches when sand lenses and other highly conductive layers exist at a depth of 3 feet or more (Skaggs 1979).

When possible, the tubing should be placed at the interface or in the top of the highly conductive layer (fig. 10-43). This decreases the hydraulic head loss caused by the convergence near the tubing. As the required spacings for the tubing decreases, a larger percentage of the total head loss occurs near the drain. The same effect can be obtained when ditches are used, but the magnitude is less because ditches incur a smaller hydraulic head loss. When ditches are installed, they should penetrate the highly conductive layer if possible.

(2) Envelopes and envelope material

Envelopes shall be used around subsurface drains if needed for proper bedding of the conduit or to improve the permeability in the zone around the drain. The main requirement of the envelope material is to have a permeability higher than that of the base material. The envelope should be at least 3 inches thick. The material does not need to meet the gradation requirements of filters, but it must not contain materials that cause accumulation of sediment in the conduit or that are unsuitable for bedding the conduit.

Envelope materials consist of sand-gravel, organic, or similar material. Sand-gravel envelope materials must all pass a 1.5-inch (3.81 cm) sieve; not more than 30 percent shall pass the No. 60 sieve; and not more than 5 percent shall pass the No. 200 sieve. Pit-run coarse sand and fine gravel containing a minimum of fines often meets this criteria. ASTM C-33 fine aggregate for concrete has been satisfactorily used and is readily available.

(3) Filters

Filters for drains are used to facilitate passage of water to the drain and to prevent movement of fine particles of silt and sand into the drain. Because of the movement into and out of conduits in water table control laterals with fluctuating hydraulic heads, the potential for siltation may be greater than in regular subsurface drains. Determining need for a filter or selecting a filter is critical. For guidance, see Engineering Field Handbook, chapter 14.

Figure 10-43 Placement of tubing or ditches within the soil profile

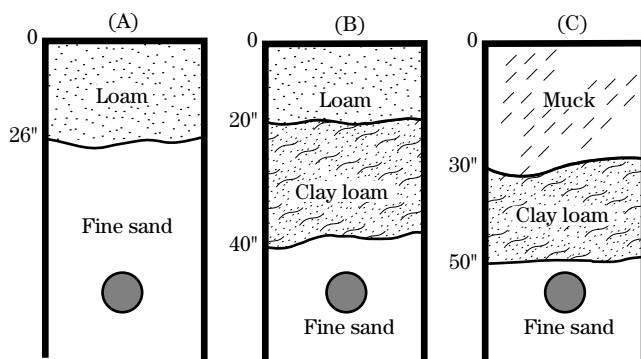

Properly graded sand and gravel filters, according to subsurface drain standard (code 606), are recommended for use around conduits in water table control systems. Filters are not always needed for coarse textured, well-graded sand. A geotextile filter can be used for fine textured, poorly graded sand, but if it is used in any other soils, test to verify that it will function satisfactorily. Tests with the soils in which the geotextile will be installed. Tests are necessary unless sufficient field installations are available in similar soils to indicate the geotextile filter has not clogged under similar water table control conditions. A knitted geotextile material or sand and gravel filter should be used where iron oxide (ochre) problems exist.

(g) Seepage losses

(1) Seepage losses from subirrigation and controlled drainage systems

The calculation of the water lost by seepage is an important consideration when determining the feasibility of a subirrigation or controlled drainage system. Guidance for calculating seepage losses and determining irrigation efficiency is in the DRAINMOD Reference Report 1980 (Skaggs 1980).

(2) Seepage losses from subirrigation and water table control systems

One of the most important components of a subirrigation system is the development of a water supply with adequate capacity to meet plant use requirements plus replenish water lost from the system by seepage. When the water table is raised during subirrigation, the hydraulic head in the field is higher than that in surrounding areas and water is lost from the system to lateral seepage. The rate of deep seepage or vertical water movement from the soil profile may also be increased. The magnitude of seepage losses depends on the hydraulic conductivity of the soil and depth to restricting layers. It also depends on boundary conditions, such as the elevation of the controlled water table in relation to surrounding water table depths and the distance to drains or canals that are not controlled.

Methods for characterizing seepage losses from subirrigated fields are presented in the following sections. The methods used are similar in concept to those described by Hall (1976) for computing reservoir water losses as affected by ground water mounds. However, water tables generally are high for subirriga-

tion systems, and seepage losses can be computed by considering flow in one or two dimensions, whereas, the reservoir seepage problem is normally a two or three dimensional problem.

(The rest of section 624.1004 (g) is from chapter 9 of the DRAINMOD Reference Report (1980). The figure and equation numbers have been changed to reflect their insertion in this chapter.) The original material was prepared using metric units and was not converted for this section.

(3) Seepage losses to nearby drains or canals

Methods for quantifying steady seepage losses in the lateral direction can be developed by considering the case shown in figure 10-44. Using the Dupuit-Forchheimer (D-F) assumptions the seepage rate may be expressed as:

$$q = -Kh \frac{dh}{dx} \quad [10-14]$$

where:

- q = the seepage rate per unit length of the drainage ditch ($\text{cm}^3/\text{cm hr}$ or $\text{ft}^3/\text{ft hr}$)
- K = effective lateral hydraulic conductivity, cm/hr or ft/hr
- h = water table elevation above the impermeable layer (cm or ft), which is a function of the horizontal position x

If evapotranspiration from the surface is assumed negligible, q is constant for all x , and equation 10-14 can be solved subject to the boundary conditions as:

$$h = h_1 \text{ at } x = 0 \quad [10-15]$$

$$h = h_2 \text{ at } x = S \quad [10-16]$$

Figure 10-44 Water table profile for seepage from a subirrigated field to a drainage ditch

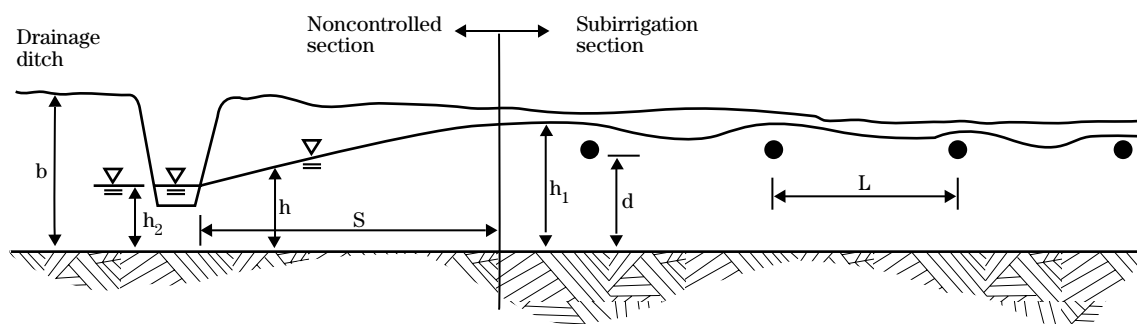

The solution for h may be written as:

$$h^2 = -\frac{h_1^2 - h_2^2}{S}x + h_1^2 \quad [10-17]$$

Differentiating equation 10-17 and substituting back into equation 10-14 gives:

$$q = \frac{K}{2S}(h_1^2 - h_2^2) \quad [10-18]$$

Then, if the length of the field (into the paper) is l , the seepage loss from that side of the field may be calculated as:

$$Q = ql = \frac{Kl}{2S}(h_1^2 - h_2^2) \quad [10-19]$$

Vertical water losses resulting from ET along the field boundaries increase the hydraulic gradients in the horizontal direction and, thus seepage losses (fig. 10-45). In this case the flux, q , may still be expressed by equation 10-14, but rather than the flux being constant we may write:

$$\frac{dq}{dx} = -e \quad [10-20]$$

where:

e = ET rate

Then substituting equation 10-14 for q :

$$\frac{d}{dx}\left(h \frac{dh}{dx}\right) = \frac{e}{K} \quad [10-21]$$

Solving equation 10-21 subject to boundary conditions equation 10-15 and equation 10-16 gives:

$$h^2 = \frac{e}{K}x^2 + \frac{\left(h_2^2 - h_1^2 - \frac{e}{K}S^2\right)}{S}x + h_1^2 \quad [10-22]$$

Again differentiating and evaluating:

$$\frac{dh}{dx} \text{ at } x = 0$$

and substituting into (10-14) yields:

$$q = \frac{K(h_1^2 - h_2^2) + eS^2}{2S} \quad [10-23]$$

Notice that for no ET ($e = 0$), equations 10-22 and 10-23 reduce to equations 10-17 and 10-18, respectively, as they should.

Figure 10-45 Water table profile for seepage from a subirrigated field

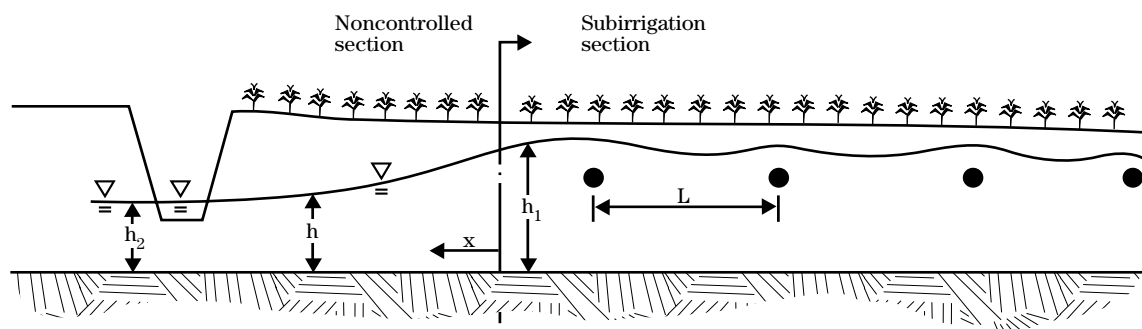

(4) Seepage losses to adjacent undrained lands

Subirrigation systems are often located next to forest land or crop land that is not drained. However seepage losses may still occur along these boundaries because of a low water table in the undrained areas. A water table can be low in surrounding areas even if the areas are not drained because ET draws down the water table where it is not being replenished by subirrigation. Such a situation is shown schematically in figure 10-46. The problem here, as opposed to the other cases mentioned is that neither h_2 nor S is known. For purposes of this problem it is assumed that water will not move to the surface (or to the root zone) at a rate sufficient to support ET for a water table elevation of less than h_2 . Using principles of conservation of mass for any point x :

$$q(x) = (S - x)e \quad [10-24]$$

where:

- $q(x)$ = flow rate per unit length of the field expressed as a function of x
- e = steady ET rate
- S = limiting distance where $h = h_2$ the limiting water table elevation that will allow upward water movement to the surface at rate e

Substituting equation 10-14 for q gives:

$$-Kh \frac{dh}{dx} = (S - x)e \quad [10-25]$$

Separating variables and integrating subject to the condition $h=h_1$ at $x=0$ yields the following expression for h :

$$h^2 = \frac{ex^2}{K} - \frac{2S ex}{K} + h_1^2 \quad [10-26]$$

Then S can be determined by substituting $h=h_2$ at $x=S$, which after simplifying results in:

$$S = \sqrt{\frac{(h_1^2 - h_2^2)K}{e}} \quad [10-27]$$

Then the seepage loss per unit length of the field may be evaluated from equation 10-24 at $x = 0$ as:

$$q = \sqrt{\frac{(h_1^2 - h_2^2)K}{e}} e \quad [10-28]$$

or

$$q = \sqrt{(h_1^2 - h_2^2)Ke} \quad [10-29]$$

Normally seepage losses to surrounding undrained areas would be highest during peak consumptive use periods. The value of h_1 would depend on the water level held in the subirrigation system. The value of h_2 would depend on the soil profile and could be chosen from relationships for maximum upward flux versus water table depth. To be on the safe side, h_2 should be chosen so that the depth of the water table is at least 1 m at $x = S$.

Figure 10-46 Seepage from a subirrigated field to an adjacent non-irrigated field that has water table drawdown because of evapotranspiration

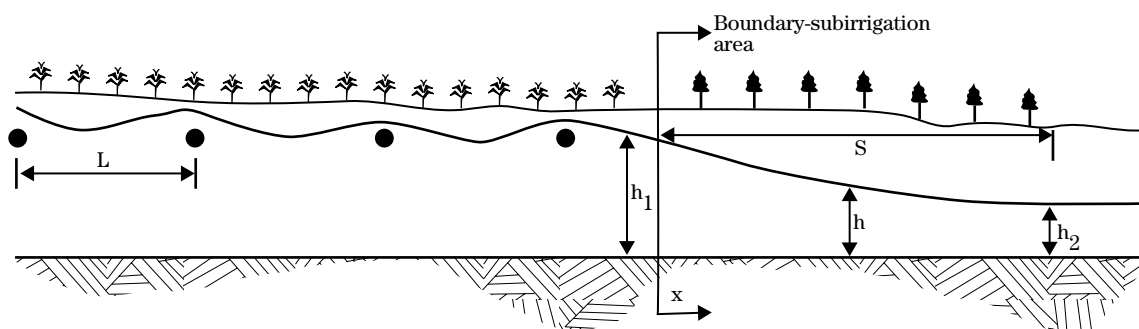

(5) Vertical or deep seepage

Subirrigation and water table control systems generally are on soils that have tight underlying layers or a high natural water table, or both, so that vertical losses are not excessive. When evaluating a potential site for a subirrigation system, vertical seepage losses under a raised water table condition should be estimated even though a natural high water table is known to exist. These losses should be added to lateral seepage estimates to determine the water supply capacity needed in addition to that required to meet ET demands.

Deep seepage can be estimated for soils that have restricting layers at a relatively shallow depth by a straightforward application of Darcy's law. Referring to figure 10-47 the vertical seepage flux may be estimated as:

$$q_v = K_v \frac{h_1 - h_2}{D} \quad [10-30]$$

where:

q_v = flux (m/d)

K_v = effective vertical hydraulic conductivity of the restricting layer

h_1 = average distance from the bottom of the restricting layer to the water table

h_2 = hydraulic head in the ground water aquifer referenced to the bottom of the restricting layer

D = thickness of the restricting layer

Figure 10-47 Vertical seepage to a ground water aquifer during subirrigation

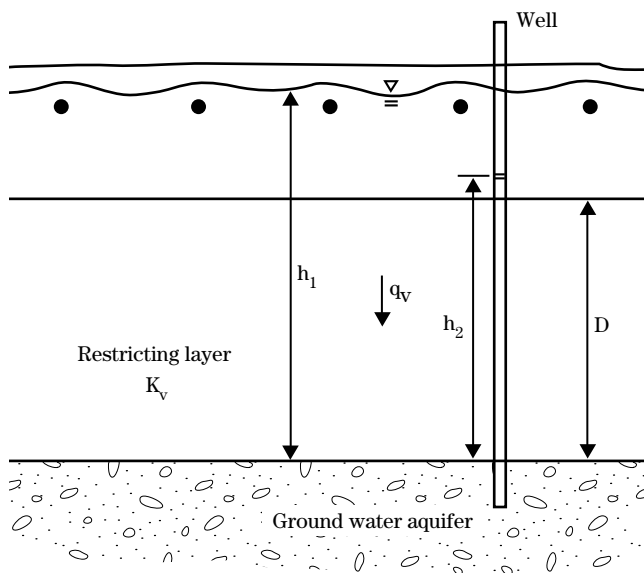

The hydraulic head in the ground water aquifer can be estimated from the water level in nearby wells. Piezometers may need to be installed to the depth of the ground water aquifer to accurately determine the hydraulic head in the aquifer. Methods for installing the piezometers are described in Part 624, Drainage of Agricultural Land, of the National Engineering Handbook. The thickness and hydraulic conductivity of the restricting layer may be determined from deep borings in the field. Data from such borings should be logged in accordance with the procedures given in part 624. The vertical hydraulic conductivity, K_v , of restricting layers can be determined from in-field pumping tests using the piezometer method (Bouwer and Jackson 1974). Laboratory tests on undisturbed cores can also be used to determine K_v ; however, field tests are preferred when possible.

The restricting strata are often composed of several layers of different conductivities and thicknesses, rather than a single layer. In this case K_v in equation 10-30 is replaced by the effective vertical hydraulic conductivity K_{ve} . K_{ve} can be calculated for flow perpendicular to a series of layers (Harr 1922) as:

$$K_{ve} = \frac{D}{\frac{D_1}{K_{v1}} + \frac{D_2}{K_{v2}} + \frac{D_3}{K_{v3}} + \dots} \quad [10-31]$$

where:

D_1, D_2, D_3, \dots = thicknesses

$K_{v1}, K_{v2}, K_{v3}, \dots$ = vertical hydraulic conductivities of the individual layers

$D = D_1 + D_2 + D_3 \dots$

Example 10-5 Seepage loss on subirrigation water table control system

Given: An example layout of a subirrigation system is shown in figure 10-48. Drains are placed 20 meters apart, and the water level directly above the drains is held to within 50 centimeters of the surface during the growing season. Seepage losses occur along all four boundaries of the field. The effective lateral hydraulic conductivity is 2 meters per day for the field and surrounding areas except for the compacted roadway south of the field where $K = 0.5$ meter per day.

Figure 10-48 Schematic of a 128 hectare (316 acre) subirrigation system showing boundary conditions for calculating lateral seepage losses

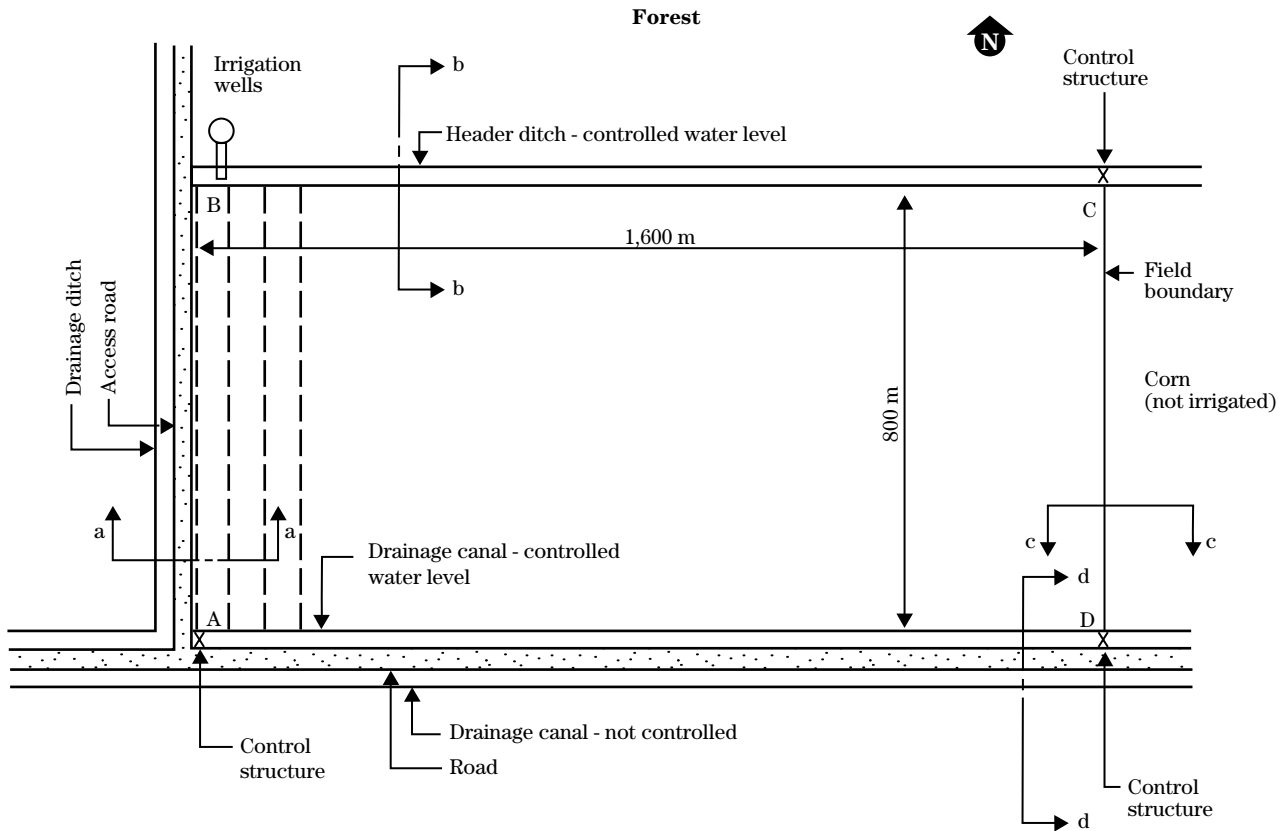

Example 10-5 Seepage loss on subirrigation water table control system—Continued

Boundary A-B: Along boundary A-B, water moves from the field under a 5 meter wide field access road to a drainage ditch on the other side (fig. 10-49a). A drain tube is located immediately adjacent to the road so that good water table control is maintained right up to the field boundary. The seepage rate under the road can be calculated using equation 10-18 as:

$$\begin{aligned} q_{A-B} &= \frac{2.0 \text{ m/d}}{2 \times 5 \text{ m}} (1.5^2 - 0.6^2) \text{ m}^2 \\ &= \frac{0.378 \text{ m}^3}{\text{m} \times \text{d}} \\ Q_{A-B} &= q \ell \\ &= \frac{0.378 \text{ m}^3}{\text{m} \times \text{d}} \times 800 \text{ m} \\ &= 302 \text{ m}^3 / \text{d} \end{aligned}$$

Converted to more familiar units the seepage rate may be written as:

$$\begin{aligned} Q_{A-B} &= 302 \text{ m}^3 / \text{day} \times \frac{1 \text{ day}}{24 \text{ hr}} \times \frac{1 \text{ hr}}{60 \text{ min}} \times \left(3.28 \frac{\text{ft}}{\text{m}} \right)^3 \times \frac{7.5 \text{ gal}}{\text{ft}^3} \\ Q_{A-B} &= 55 \text{ gal / min} \end{aligned}$$

This rather high seepage loss can be reduced by moving the first lateral away from the edge of the field, for example, by half of the drain spacing (fig. 10-49b). Then substituting $S = 10 + 5 = 15 \text{ m}$ in equation 10-19 gives:

$$\begin{aligned} Q_{A-B} &= \frac{2.0 \text{ m / day} \times 800 \text{ m}}{2 \times 15 \text{ m}} (1.5^2 - 0.6^2) \\ &= 100 \text{ m}^3 / \text{day} \\ &\text{or} \\ Q_{A-B} &= 18 \text{ gal / min} \end{aligned}$$

This would be the seepage rate when $ET = e = 0$.

Figure 10-49 Seepage along boundary A-B

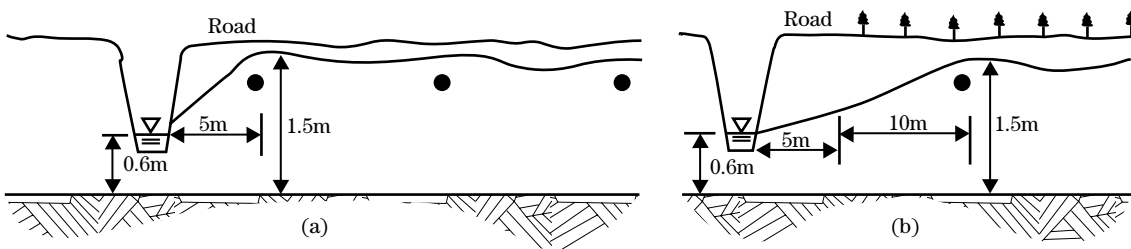

* The first drain tube (a) is located immediately adjacent to the field access road 5 meters from the drainage ditch, and the first drain tube (b) is located 10 meters back from the road.

Example 10-5 Seepage loss on subirrigation water table control system—Continued

Seepage losses are most critical during periods of high consumptive use (high ET by crop) because it is at this period that the highest supply rate is required. The seepage rate for a design ET value of $e = 0.6$ cm can be calculated using equation 10-20:

$$\begin{aligned}
 q_{A-B} &= \frac{2.0 \text{ m} / d(1.5^2 - 0.6^2) \text{ m}^2 + .006 \text{ m} / \text{day} \times 15^2 \text{ m}^2}{2 \times 15 \text{ m}} \\
 &= \frac{0.171 \text{ m}^3}{\text{m} \times \text{day}} \\
 Q_{A-B} &= q \ell \\
 &= \frac{0.171 \text{ m}^3}{\text{m} \times \text{day}} \times 800 \text{ m} \\
 &= 137 \text{ m}^3 / \text{day}
 \end{aligned}$$

or

$$Q = 25 \text{ gal} / \text{min}$$

However, it should be noted that this is the flow rate from the first lateral toward the access road and the adjacent drainage ditch. Part of the water supplies the ET demand between the lateral and the ditch and should not be counted as seepage loss. The rate of water used in the 10-meter strip between the first lateral and the access road is:

$$\begin{aligned}
 Q_e &= 0.006 \text{ m} / \text{day} \times 10 \text{ m} \times 800 \text{ m} \\
 &= 48 \text{ m}^3 / \text{day}
 \end{aligned}$$

then:

$$Q_{A-B} = 137 \text{ m}^3 / \text{day} - 48 = 89 \text{ m}^3 / \text{day} = 16 \text{ gal} / \text{min}$$

This includes water lost by seepage to the drainage ditch plus water lost by ET from the road surface (at an assumed rate of 0.6 cm/d) where grass, weeds, and other plants are growing. Note that the same result would have been obtained by evaluating the quantity $h \, dh/dx$ from equation 10-12 at $x = 10$ m rather than at $x = 0$. Equation 10-13 would then have been replaced by:

$$q = -e \, x + \frac{K}{2S} \left(h_1^2 - h_2^2 + \frac{e}{K} S^2 \right) \quad [10-32]$$

and

$$q_{A-B} = -.006 \times 10 + \frac{2.0}{2 \times 5} \left(1.5^2 - .6^2 + \frac{.006}{2} \times 15^2 \right)$$

$$q_{A-B} = \frac{0.111 \text{ m}^3}{\text{day} \times \text{m}} \times 800 \text{ m}$$

$$Q_{A-B} = 0.111 \times 800 = 88.8 \text{ m}^3 / \text{day} = 16 \text{ gal} / \text{min}$$

Example 10-5 Seepage loss on subirrigation water table control system—Continued

This is the same as that already determined above.

Seepage losses for $e = 0$ are greater than those for $e=0.6$ centimeters per day. This is because ET within the field lowers the water table elevation at the field edge, reducing the hydraulic gradient and seepage rates. Losses can be further reduced by moving the first lateral further away from the field boundary. This may mean sacrificing the quality of water table control near the edge of the field, but should be considered if seepage losses are excessive.

Boundary B-C: Seepage losses along the north boundary, B-C, are in response to gradients caused by water table drawdown by ET (fig. 10-50).

Figure 10-50 Schematic of water table position along the north boundary (section b-b)

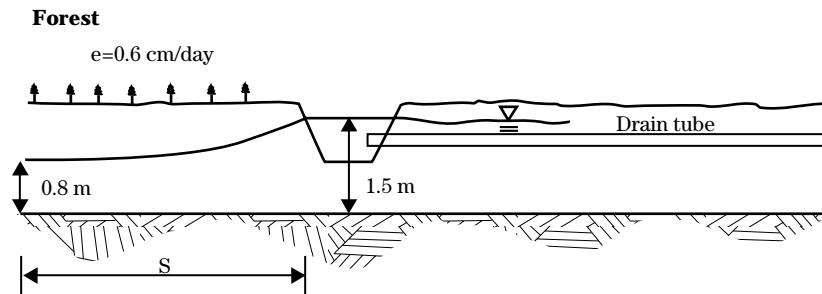

Example 10-5 Seepage loss on subirrigation water table control system—Continued

The relationship between maximum upward flux and water table depth indicate that, for a particular silt loam soil, an ET rate of 0.6 centimeters per day can be sustained with a water table depth below the root zone of 50 centimeters and a rate of 0.2 centimeters per day at a depth of 60 centimeters. Assuming an effective rooting depth of 60 centimeters (2 ft) and taking a conservative estimate of 60 centimeters for the water table depth below the root zone gives a total water table depth of 1.2 meters and $h_2 = 2.0 - 1.2 = 0.8$ meters. The seepage rate can then be determined from equation 10-29:

$$q_{B-C} = \sqrt{(1.5^2 - 0.8^2)} 2.0 \times 0.006 \text{ m}^3 / \text{m} \times \text{day}$$

$$= 0.139 \text{ m}^3 / \text{m} \times \text{day}$$

$$Q_{B-C} = 1600 \text{ m} \times q_{B-C}$$

$$= 222 \text{ m}^3 / \text{day}$$

$$= 41 \text{ gal} / \text{min}$$

Seepage along B-C increases with the square root of e . This is in contrast to boundary A-B where seepage losses decrease with increasing e . A 25 percent increase in h_2 to 1 meter still gives a seepage rate of 36 gallons per minute, a reduction of only 12 percent.

Boundary C-D: As in boundary B-C, seepage losses along C-D are caused by a lower water table in the adjacent nonirrigated field that was drawn down by ET (fig. 10-51).

Figure 10-51 Schematic of water table and seepage along the east boundary (section c-c)

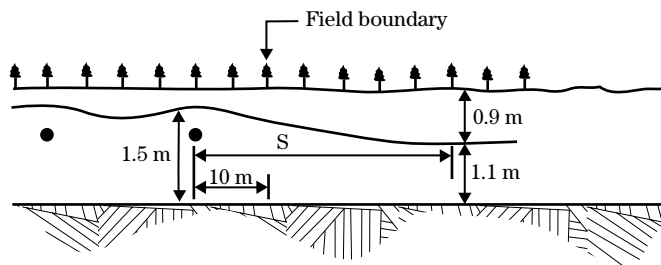

Example 10-5 Seepage loss on subirrigation water table control system—Continued

By assuming an effective maximum root depth for corn of 30 centimeters and a water table depth below the root zone of 60 centimeters:

$$y = 0.60 + 0.30 = 0.90$$

so,

$$\begin{aligned} h_2 &= 2.0 - 0.90 \\ &= 1.1\text{m} \end{aligned}$$

For a steady ET rate of 0.6 centimeters per day, the seepage rate from the last drain tube toward the boundary C-D is calculated using equation 10-29:

$$\begin{aligned} q &= \sqrt{(1.5^2 - 1.1^2)} 2.0 \times 0.006 \\ &= 0.112 \text{ m}^3 / \text{m day} \end{aligned}$$

However, part of this seepage supplies the ET demand for the region between the last tube and the field boundary and should not be considered as seepage loss. If the last drain tube is located 10 meters from the edge of the field, the portion of the above seepage used by ET within the irrigated field is:

$$\begin{aligned} q_e &= (0.006 \text{ m / d}) \times 10\text{m} \\ &= 0.06 \text{ m}^3 / \text{m d} \end{aligned}$$

Therefore:

$$q_{C-D} = 0.112 - 0.06 = 0.052 \text{ m}^3 / \text{m} \times \text{day}$$

and

$$\begin{aligned} Q_{C-D} &= (0.052 \text{ m}^3 / \text{m} \times \text{d}) \times 800 \text{ m} \\ &= 41 \text{ m}^3 / \text{d} \\ &= 7.5 \text{ gal / min} \end{aligned}$$

An alternative means of calculating this loss is to first determine S for which $h = h_2 = 1.1 \text{ m}$ (from eq. 10-27).

$$S = \sqrt{(1.5^2 - 1.1^2)} \frac{2.0}{.006} = 18.6 \text{ m}$$

Then determine q_{C-D} from equation 10-40 with $x=10 \text{ m}$:

$$q_{C-D} = .052 \text{ m}^3 / \text{m d}$$

This is the same value obtained above.

Example 10-5 Seepage loss on subirrigation water table control system—Continued

Boundary A-D: Seepage under the road along boundary A-D (fig. 10-52) can be estimated using equation 10-19 with K for the compacted road fill of 0.5 meters per day.

$$Q_{A-D} = \frac{0.5 \text{ m / day} \times 1,600 \text{ m}}{2 \times 15 \text{ m}} (1.5^2 - 0.7^2)$$

$$\begin{aligned} Q_{A-D} &= 47 \text{ m}^3 / \text{m day} \\ &= 8.5 \text{ gal / min} \end{aligned}$$

Deep seepage: Deep borings and hydraulic conductivity tests using the piezometer method indicate the thickness of the restricting layer is 20 meters with an effective vertical hydraulic conductivity of $K_v = 0.01$ centimeters per hour. Measurements in observation wells, cased to the depth of the ground water aquifer (22 m deep), show a nearly constant hydraulic head of $h_2 = 20.5$ meters (fig. 10-50). Then assuming an average $h_2 = 21.3$ meters, the vertical seepage rate can be calculated using equation 10-30:

$$\begin{aligned} q_v &= 0.01 \text{ cm / hr} \frac{21.3 \text{ m} - 20.5 \text{ m}}{20 \text{ m}} \\ &= 0.0004 \text{ cm / hr} \\ &= 0.000096 \text{ m / d} \end{aligned}$$

The entire field with dimensions of 800 x 1,600 meters has a vertical seepage rate of:

$$\begin{aligned} Q_v &= q_v A \\ &= 0.000096 \times 800 \times 1,600 \\ &= 123 \text{ m}^3 / \text{day} \\ &= 22 \text{ gal / min} \end{aligned}$$

Figure 10-52 Seepage under the road along boundary A-D (section d-d)

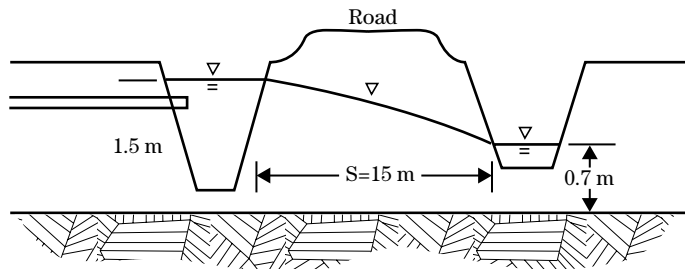

Example 10-5 Seepage loss on subirrigation water table control system—Continued**Total seepage losses**

Based on the previous calculations the total seepage losses are:

$$\begin{aligned} Q_T &= Q_{A-B} + Q_{B-C} + Q_{C-D} + Q_{A-D} + Q_v \\ &= 89 + 222 + 41 + 47 + 123 \\ &= 522 \text{ m}^3 / \text{d} \end{aligned}$$

or

$$Q_T = 96 \text{ gal} / \text{min}$$

This amount of water must be supplied in addition to the irrigation water necessary to satisfy ET demand during the operation of the subsurface irrigation system. The calculations are based on a peak ET rate of 0.6 centimeters per day. Therefore, the capacity required to satisfy ET during periods of dry weather when the total demand must be satisfied by the subirrigation system is:

$$\begin{aligned} Q_{ET} &= 0.6 \text{ cm} / \text{d} \times \frac{1 \text{ m}}{100 \text{ cm}} \times 800 \text{ m} \times 1,600 \text{ m} \\ &= 7,680 \text{ m}^3 / \text{d} \text{ or } 1,400 \text{ gal} / \text{min} \end{aligned}$$

or

$$\begin{aligned} Q_C &= 7,680 + 522 \\ &= 8,200 \text{ m}^3 / \text{d} \text{ or } 1,500 \text{ gal} / \text{min} \end{aligned}$$

Thus the seepage loss expressed as a percentage of the total capacity is:

$$\text{Percentage loss} = \frac{522}{8200} \times 100 = 6.4\%$$

This is quite reasonable compared to conventional methods of irrigation.

(h) Fine tuning the design

After field, crop, and site parameters have been determined, the final drain spacing, drain depth, water table level, and management strategy can be designed. The most important consideration at this time is to determine the drain spacing.

Historically, drain spacings have been selected from the drainage guide based on local experience and past performance in the area. The drainage guide contains recommendations on drain spacings for average soil and site condition. Normally, the recommendations for mineral soils are based on a drainage coefficient of 3/8 to 3/4 inch per day. While this method is quite good for average conditions, it does not provide the optimum design for all the possible conditions encountered in an individual field.

Most drainage guides were developed for drainage only, and subirrigation requirements are different. Several methods are now available for selecting drain spacings. All of the methods provide a better estimate of the optimum drain spacing if the saturated hydraulic conductivity and depth to impermeable layer are determined in the field rather than using average values from the soil survey or drainage guide.

Water table management involves drainage and irrigation. The operation of the system varies from day-to-day and from year-to-year whether in the drainage or subirrigation mode. Whether the greatest need is to provide good drainage under a high water table condition or sufficient subirrigation during drought is not clear. The complex nature of designing systems for water table control led to the research and development of computer models which are now used for that purpose.

The DRAINMOD approach is a method presently available for the complete analysis and design of a subirrigation and subsurface drainage system. The DRAINMOD model uses computerized simulations of a water table control system based upon past long-term weather records (rainfall and temperature) and onsite soil parameters. The model was designed for use in humid regions, and its routine application is limited to those regions. It has, however, been tested in arid areas and may be used for irrigated arid regions where the water table is shallow and drainage is required.

Application to arid areas should be performed using a potential evapotranspiration (PET) data file rather than the Thornthwaite PET estimates computed internally using DRAINMOD. If DRAINMOD is used, the final design should be based on several simulations; however, a good estimate of the drain spacing can be obtained from some of the shortcut methods that have been developed. Using these shortcut methods reduces the number of simulations required. Shortcut methods that can be used to select the preliminary drain spacing for subirrigation are:

- Fixed percentage of the spacing shown in the drainage guide.
- Fixed percentage of the spacing required for drainage alone using the Hooghoudt's steady state drainage equation.
- Drain spacing based on steady state evapotranspiration (ET) for subirrigation only.

Each of these methods is described earlier in the design (section 624.1004). When being used to estimate drain spacing, it is not critical which shortcut method is used because each method provides reasonable estimates.

(1) Fine tuning the design using DRAINMOD

Once the spacing has been estimated using one of the short cut methods, the final system design may be determined using DRAINMOD. The use of DRAINMOD requires a number of specific climate and soils data. The recommended procedure for using the model follows:

Step 1—Measure hydraulic conductivity and depth to impermeable layer at several locations in the field (see section 624.1003 for details).

Step 2—Using one of the shortcut methods, calculate a first estimate of the drain spacing. See sections 624.1004(e) and 624.1003(h).

Step 3—Either measure or select additional soil information using appropriate benchmark soils available:

- Soil water characteristics
- Upward flux
- Infiltration parameters

Step 4—Select crop information data available:

- Root depth versus time
- Wilting point
- Crop stress factors

Step 5—Get weather data including hourly rainfall for site location.

Step 6— Run DRAINMOD:

- Start with estimated spacing from step 2.
- Select two simulation spacings both above and below the first estimate from step 6a (5 spacings will be simulated).
- Plot these spacings versus simulated yield, and select the spacing with the highest yield. Then select a second spacing approximately 5 to 10 feet wider than the spacing with the highest yield.
- For the two spacings selected, run additional simulations and this time vary the weir setting. Normally weir settings of 18, 21, and 24 inches are best. In some cases a higher setting may be justified (shallow rooted crop in coarse sand), and occasionally a lower setting may be better (deep rooted crop in clayey soil).

Step 7—Perform an economic evaluation for all of the simulations using the procedures in section 624.1004.

Step 8—Select the spacing and weir setting with the highest projected net profit. This will be the design spacing and weir setting.

Step 9—Finally, using the spacing and weir setting selected in step 8, run three or four additional simulations, varying the start-up time for subirrigation from 7 to 10 days for normal planting season. Evaluate water usage and pumping cost for the different startup times, and select the combination that results in the maximum net profit. This would be the best design and management system to recommend.

(2) Fine tuning the design using a shortcut procedure

The final design may be determined using one of the shortcut procedures in situations where DRAINMOD cannot be run. These situations include:

- A computer is not available.
- Sufficient input data are not available.
- Farmer desires design spacing on short notice.

Unfortunately, no one shortcut method provides a good estimate for all soil and site conditions; however, one method, the Design Drainage Rate method (DDR), does a reasonably good job for most soil conditions (Skaggs, et al. 1985, 1986). Figure 10–53 can help determine the tubing spacing for subirrigation using the DDR method.

The DDR method predicts drain spacings that most closely approximate the spacing that would be predicted using DRAINMOD. It uses the Hooghoudt steady drainage equation with a predetermined design drainage rate. The drain spacing for drainage is determined by:

$$S_d = \left[\frac{4K_e m (2d_e + m)}{\text{DDR}} \right]^{\frac{1}{2}} \quad [10-33]$$

Historically, DDR values of 0.5 inches per day for grain crops and 0.75 inches per day for vegetable crops have been used. The criterium traditionally used to determine **m** has been to assume that the water table needed to be 12 inches below the soil surface.

A study (Skaggs and Tabrizi 1984) using 12 benchmark soils indicated that a better estimate for the DDR for corn were 0.44 inch per day with good surface drainage and 0.51 inch per day with poor surface drainage. This method predicted drain spacings that most closely approximated the design spacing predicted by DRAINMOD when **m** was assumed equal to depth of drain (i.e., the steady state water table position was at the soil surface rather than 12 inches deep). When these values were used, the spacing determined by the DDR method would result in average profits that were at least 90 percent of the optimum profit about 90 percent of the time.

Occasionally, the spacing predicted by this method resulted in profits that were less than 70 percent of the optimum profit. These cases with poor design spacings could not be correlated with soil properties, but in general, the predicted spacing was too narrow for soils with very low K values and too wide on soils with very high K values. DRAINMOD is the most desirable way to determine the final design spacing, although the DDR method is believed to be the best shortcut method available.

A design drainage rate for crops other than corn has not yet been determined. Corn is one of the more sensitive crops to water during critically wet and dry periods. Corn is one of the first crops planted during the spring and can also be more restrictive from the standpoint of trafficability than many other crops. When the subirrigation system is being designed for grain crops (corn, soybeans or wheat), the optimum design spacing for corn will also be adequate for soybeans or wheat under most conditions. When the

major crops are not grain, the spacing could still be determined using the values for corn, or one of the other shortcut methods could be used.

When using the DDR method, the subirrigation drain spacing is determined by multiplying the design sub-surface drain spacing by 0.63 if good surface drainage is available, or by 0.61 if poor surface drainage is provided. Example 10-6 demonstrates the use of this method for estimating design spacing.

Figure 10-53 Determining the tubing spacing for subirrigation using the design drainage rate method

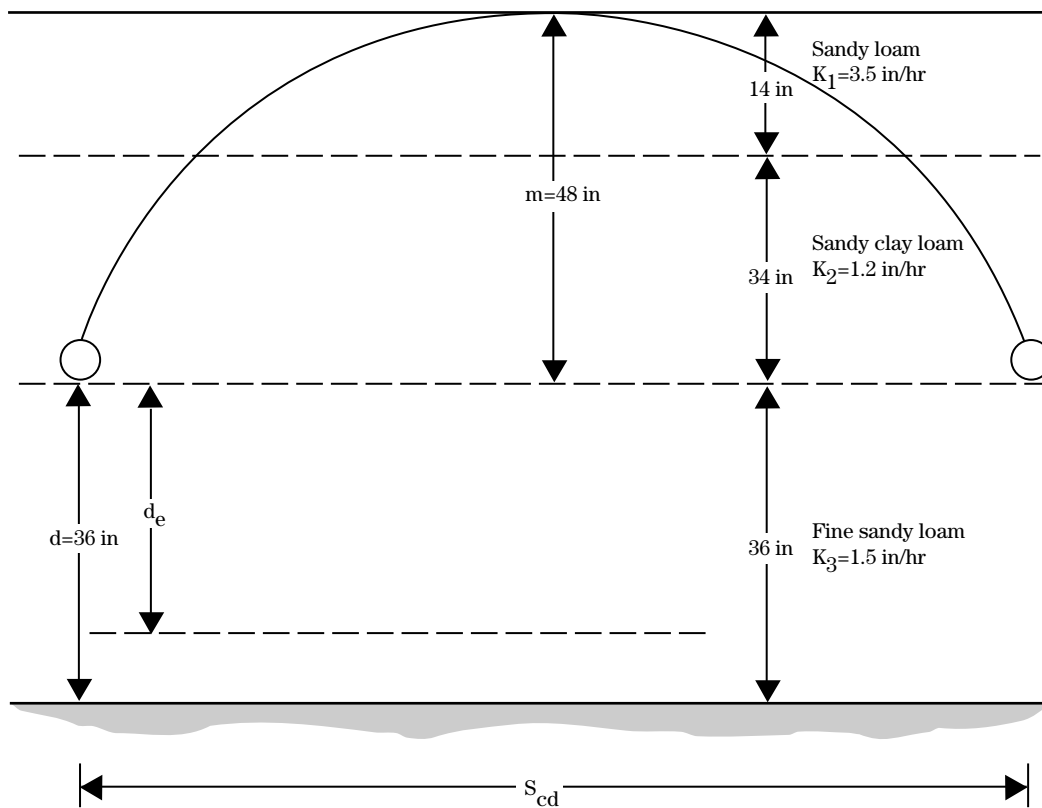

Example 10-6 Design drainage rate method

Given: Corn will be grown on a soil with a maximum root depth of 24 inches. The site has good surface drainage. Refer to figure 10-53 for details.

Determine: Determine the drain spacing needed to provide subirrigation using the design drainage rate (DDR) method.

Solution: **Step 1**—Determine the gradient **m** between drains. Using the DDR method, we assume that the water table at the midpoint between drains is at the surface. Therefore, **m** is equal to the drain depth of 4 feet.

Step 2—Since this site has good surface drainage, the design drainage rate is 1.1 centimeters per day, which is 0.433 inch per day = .018 inch per hour.

Step 3—Determine the equivalent hydraulic conductivity (K_e). Since flow occurs over the entire profile, the hydraulic conductivity is:

$$K_e = \frac{(14 \text{ in} \times 3.5 \text{ in/hr}) + (34 \text{ in} \times 1.2 \text{ in/hr}) + (36 \text{ in} \times 1.5 \text{ in/hr})}{14 \text{ in} + 34 \text{ in} + 36 \text{ in}}$$

$$= 1.71 \text{ in/hr}$$

Step 4—Determine the first estimate of the drain spacing needed for drainage using equation 10-5. As with the previous examples, d_e is needed. For the first calculation of S_d assume d_e is equal to d , which is 3 feet:

$$S_d = \left[\frac{4K_e m (2d + m)}{q} \right]^{\frac{1}{2}}$$

$$S_d = \left[\frac{4 \times 1.71 \text{ in/hr} \times 4 \text{ ft} (2 \times 3 \text{ ft} + 4 \text{ ft})}{.018 \text{ in/hr}} \right]^{\frac{1}{2}}$$

$$= 123.3 \text{ ft}$$

Example 10-6 Design drainage rate method—Continued

Step 5—Now determine d_e using Hooghoudt's equation and the value of $S_d=123.3$ just determined using equation 10-7:

$$\begin{aligned} d_e &= \frac{d}{1 + \frac{d}{S} \left[\frac{8}{\pi} \text{Ln} \left(\frac{d}{r_e} \right) - 3.7 \right]} \\ &= \frac{3}{1 + \frac{3}{123.3} \left[2.55 \text{Ln} \left(\frac{3}{0.17} \right) - 3.4 \right]} \\ &= 2.74 \text{ ft} \end{aligned}$$

Step 6—Recalculate S_d using the new value of $d_e = 2.41$ ft:

$$\begin{aligned} S_d &= \left[\frac{4 \times 1.71 \times 4(2 \times 2.74 + 4)}{.018} \right]^{\frac{1}{2}} \\ &= 120.0 \text{ ft} \end{aligned}$$

Step 7—Recalculate d_e for $S_d = 112$ ft:

$$\begin{aligned} d_e &= \frac{3}{1 + \frac{3}{120} \left[\frac{8}{\pi} \text{Ln} \left(\frac{3}{.017} \right) - 3.4 \right]} \\ &= 2.41 \text{ ft} \end{aligned}$$

Step 8—Recalculate S_d for $d_e = 2.38$ ft:

$$\begin{aligned} S_d &= \left[\frac{4 \times 1.71 \times 4(2 \times 2.41 + 4)}{.018} \right]^{\frac{1}{2}} \\ &= 112.0 \end{aligned}$$

This is close enough to the previous value that no further iteration is necessary. Using the design drainage rate method, this is the spacing recommended for drainage alone. To determine the spacing for subirrigation requires one additional step.

Example 10-6 Design drainage rate method—Continued

Step 9—Determine the fixed percentage of the design drainage rate. Since good surface drainage was provided, the fixed percentage is 0.63.

$$\begin{aligned} S_s &= 0.63 S_d \\ &= 0.63(112 \text{ ft}) \\ &= 72.9 \text{ ft} \end{aligned}$$

Using this method, the design spacing for subirrigation is 72.9 feet. This compares favorably with the design spacing of 80 feet actually determined for this example using DRAINMOD. For comparison, the estimated spacing as determined by each shortcut method is shown in table 10-2.

Table 10-2 Comparison of estimated drain spacing for subirrigation for example 10-6

Method	Estimated spacing
Fixed percentage of drainage guide (65% of 100 ft)	65
Drainage during controlled drainage (Example 10-3)	59
Subirrigation using design ET value (Example 10-4)	49
Fixed percentage of design drainage Rate: Skaggs (Example 10-6)	73
DRAINMOD	80

(i) Economic evaluation of system components

The water table control system may be technically feasible, but the final decision should be based on an economic evaluation of the system.

The three major costs of a water table control for average conditions are the cost of the water supply, underground tubing, and landgrading. Other costs to consider are control structures, culverts, drop inlet

pipe, field borders, and annual operating and maintenance expenses. These costs are site specific, so in preparing an economic analysis, the actual cost of each of these components should be obtained from manufacturers and contractors. For the purpose of example, some estimates of these component costs for average conditions are presented. These values should be interpreted as a guide only and the actual cost for a particular system may vary by two to three times the values used in example 10-7.

Example 10-7 Economic evaluation

To determine the economic feasibility of one or more water management strategies, the cost of each system component should be evaluated for each specific site. This example guides you through this process. Several assumptions were made to provide this example site.

Given:

- The site contains 100 acres.
- The site has been farmed for several years, but is naturally poorly drained. A main outlet ditch with lateral ditches at an interval of 300 feet was installed when the site was first prepared for field crops. However, in its present condition, the drainage system (predominantly surface drainage) is inadequate and is the most dominant factor limiting yields.
- Several small depressional areas (about 5% of the total cultivated area) has water accumulations which nearly drown the crop in many years.
- Even though this site is poorly drained, yields are also suppressed due to drought stress in some years.

Some of the major component costs used in the economic evaluation are summarized in tables 10-3 and 10-4. These values are average values as determined from manufacturers' literature, discussions with sales representatives, or actual costs as quoted by farmers who have installed systems. While these values are reasonable for the specific conditions assumed, they should be used only as a guide and where possible, exact values for the specific situation should be used instead.

Determine: Economic feasibility of one or more water management strategies.

Solution: The individual components necessary to make up a complete system vary, depending on the particular option being considered. An example calculation is described for each component.

Total annual costs are normally divided into two categories: fixed costs and variable costs. Fixed costs include depreciation, interest, property taxes, and insurance. Insurance would be recommended on components subject to damage or theft. Most components of a subsurface drainage or subirrigation system are underground. Therefore, it is probably unnecessary to protect these components with insurance; so, insurance was not considered in this example.

Example 10-7 Economic evaluation—Continued

Also, property tax values vary from county to county, are generally small compared to the other component costs, and were neglected. However, when the tax rate is known for a given location, it could be considered in the economic evaluation.

Depreciation and interest costs can be determined together by using an amortizing factor for the specific situation. The amortization factor considers the expected life of the component and the interest rate. Once these are known, the factor can be determined from amortization tables.

In this example, the interest rate was assumed to be 12 percent and a design life of either 15, 20, or 30 years was used, depending on the particular component. Amortization factors were 0.14682 for 15 years; 0.13388 for 20 years; and 0.12414 for 30 years. Most economic textbooks contain a table of amortization factors for a wide range of interest rates and design lives. Your local banker or financial planner/accountant could also provide these values. The amortized cost that must be recovered annually is then determined as:

$$\text{Annual amortized cost} = (\text{initial cost}) \times (\text{amortization factor})$$

Table 10-3 Description and estimated cost of major components used in economic evaluation of water management alternatives

Component	Description/specifications	Initial Cost
Drainage tubing	All tubing is 4-in corrugated plastic pipe with filter (installed)	\$ 1.00/ft
Water supply		
Deep well	8-in gravel packed, 300 ft deep, 80-ft vertical lift, 700 gpm (@ \$50/ft)	15,000
Subirrigation pump & power unit	25-hp vertical hollow shaft electric motor with single stage deep well turbine (230V, 3-phase power supply, 3450 rpm, 75% pump efficiency)	7,000
Center pivot pump & power unit	50-hp vertical hollow shaft electric motor with 3-stage deep well turbine (230V, 3 phase power supply, 3,450 rpm, 82% pump efficiency)	12,750
Surface water supply	River, stream, creek, or major drainage canal	—
Subirrigation pump & power unit	8-hp air cooled engine drive, type A single stage centrifugal pump rated at 700 gpm @ 40-ft TDH	3,500
Center pivot pump & power unit	40-hp air cooled engine drive, type A single stage centrifugal pump rated at 700 gpm @ 125-ft TDH	8,500
Control structure	Used average value for aluminum or galvanized steel: 6-ft riser, 36-in weir, 24-in outlet, 30-ft outlet pipe (installed)	1,650
Center pivot	Low pressure (30 psi) 1,200 ft long w/ 6-5/8 in dia. galvanized pipe @ \$30/ft	36,000

Example 10-7 Economic evaluation—Continued

Variable costs include any costs that vary according to how much the equipment is used. These costs include repair and maintenance, fuel, and labor. It is customary to estimate repair and maintenance costs as either a fixed percentage of the initial investment for such components as tubing, pumps and motors; a fixed rate or percentage per hour of use for each component, such as an internal combustion engine; and as a fixed rate per year, for a land-graded surface drainage system. Fuel and labor costs should be estimated based on the anticipated usage. The criteria used to determine the variable costs in the example are summarized in table 10-4.

Table 10-4 Variable costs used in economic evaluation of water management options

Component	Description/specification/basis	Cost
Repair and maintenance		
Drainage tubing	Fixed percentage of initial cost	2%/yr
Control structure		
Water supply		
Well	None assumed	—
Pumps & power units	Fixed percentage of initial cost	1%/yr
Center pivot	Fixed percentage of initial cost	1%/yr
Landgrading*	Fixed percentage of initial cost	6.4%/yr
Fuel		
Subirrigation		
Well	21.0 brake hp required (assumed 75% turbine eff, 90% motor eff @ \$.07/kw-hr)	1.47%/hr
Surface source	6.2 brake hp required (@ 20 ft TDH, 80% pump eff, 75% engine eff, 11 hp-hr/gal gasoline @ \$1.10/gal, oil & filter @ 15% of fuel)	.71/hr
Center pivot		
Well	44.6 brake hp required (assumes 80% turbine eff, 90% motor eff, @ \$.07/kw-hr)	3.12/hr
Surface source	37.6 brake hp required @ 112 ft TDH, 70% pump eff, 75% engine eff, 15.5 hp-hr/gal diesel @ \$1.10/gal)	2.67/hr
Self-propulsion	6 towers w/lhp motor each, half of motors operating at any given time requiring 3 hp, 85% eff @ \$.07/kw-hr	.25/hr
Labor		
Subirrigation	Based on 0.5 hr/d from May 1 to July 31 to check water level in observation wells, adjust riser level, etc., @ \$5.00/hr, 100 acres	2.30/ac
Center pivot	Based on 0.05 hr/ac-in, 7 ac-in/yr @ \$5.00/hr, 100 acres	2.30/ac

* Based on estimates by farmers of \$8 per acre per year where the initial cost was \$125 per acre.

Example 10-7 Economic evaluation—Continued**Drainage tubing**

Drainage tubing costs are determined by first determining the length of tubing required for a given spacing. For a spacing of 60 feet:

$$\begin{aligned}
 \text{length / acre} &= \frac{\text{area}}{\text{spacing}} \\
 &= 43,560 \text{ ft}^2 / \frac{\text{ac}}{60 \text{ ft}} \\
 &= 726 \text{ ft / ac} \\
 &= \$435.60 / \text{ac initial investment}
 \end{aligned}
 \tag{10-34}$$

Tubing cost can be amortized over 30 years. Thus, the annual amortized costs would be:

$$\text{annual amortized costs} = \$435.60 / \text{ac} \times .12414 = \$54.08 / \text{ac}$$

The operating costs (repair and maintenance) for drain tubing are estimated as 2 percent of the annual amortized costs. Thus, for the 60-foot spacing:

$$\begin{aligned}
 \text{operating costs} &= .02 \times \$54.08 \\
 &= \$1.08 / \text{ac}
 \end{aligned}$$

Control structure

The surface elevations in the example field vary by 2.5 feet. To provide adequate water table control in this field, assume three control structures are needed.

$$3 \text{ structures} \times \$1,650 / \text{structure} = \$4,950 \text{ initial investment}$$

The expected life of a control structure is about 20 years.

$$\text{annual amortized costs} = \$4,950 \times .13388 = \$662.71$$

This value represents the control structure costs for the entire 100 acre field. The per acre annual cost would be:

$$\frac{\$662.71}{100 \text{ acres}} = \$6.63 / \text{ac}$$

Operating costs (repair and maintenance) for the control structures can also be estimated as 2 percent of the annual amortized costs.

$$\begin{aligned}
 \text{operating costs} &= .02 \times \$6.63 / \text{ac} \\
 &= \$.13 / \text{ac}
 \end{aligned}$$

The operating costs for the control structure are so small that they are neglected throughout the remainder of this example. This situation normally occurs on large, flat fields. When fields are small, however, repair and maintenance costs for the control structures should be considered.

Example 10-7 Economic evaluation—Continued**Water supply—deep well**

The expected life of a deep well is about 30 years, and the life of the pump and electric power unit is about 20 years.

$$\begin{array}{rcl} \text{Well} & = & \$15,000 \times 0.12414 = \$1,862.10 \\ \text{Annual amortized cost: Pump and power unit} & = & \$7,000 \times 0.13388 = \$937.16 \\ \text{Total annual water supply} & & = \mathbf{\$2,799.26} \end{array}$$

This is the cost for the entire 100 acres. The per acre cost is:

$$\frac{\$2,799.26}{100 \text{ acres}} = \$27.99 \text{ per acre}$$

Normally, no operating costs are associated with the water source. Repair, maintenance, and fuel costs are considered for the pump and power unit. Using the pump/power unit for the subirrigation system, the repair and maintenance costs would be estimated as 1 percent of the initial cost. Thus:

$$\text{repair and maintenance} = \$7,000 \times .01 = \$70 \text{ /year}$$

Since this is the cost for the entire 100 acres, the per acre cost is:

$$\frac{70}{100} = \$.70 \text{ / ac}$$

Fuel costs vary depending on the amount of water that must be applied, the friction loss in the system, and the operating pressure of the system. For the example area, average irrigation volumes range from 6 to 8 acre-inches per year. This example uses 7 inches per year. Subirrigation may only be about 75 percent efficient because of the water loss by seepage to nonirrigated areas. Thus, the total amount of water that must be pumped to provide 7 acre-inches of usable water is:

$$\frac{7}{.75} = 9.33 \text{ ac - in / yr}$$

To pump 9.33 acre-inches of usable water on 100 acres with a 700-gpm capacity pump requires 603.4 hours per year. The power required to pump the water can be determined by:

$$\text{hp} = \frac{\text{flow (gpm)} \times \text{total dynamic head (ft)}}{3,960 \times \text{pump efficiency} \times \text{motor efficiency}} \quad [10-35]$$

Assume that the subirrigation water must be lifted 80 feet in the well and is discharged into an open ditch with 0 discharge pressure. For a pump efficiency of 75 percent and an electric motor efficiency of 90 percent, the power required for subirrigation is:

$$\begin{aligned} \text{hp} &= \frac{700 \text{ (gpm)} \times 80 \text{ (ft)}}{3,960 \times .75 \times .90} \\ &= 21.0 \text{ hp} \end{aligned}$$

Example 10-7 Economic evaluation—Continued

The energy costs required to provide this power is then:

$$21.0 \text{ hp} \times 1 (\text{kw} / \text{hp}) \times \frac{\$.07 / \text{kw}}{\text{hr}} = \$1.47 / \text{hr}$$

As previously determined, 603.4 hours would be required to provide the irrigation water for the entire 100 acres, thus the pumping cost per acre is:

$$\frac{\$.147 / \text{hr} \times 603.4 \text{ hr}}{100 \text{ ac}} = \$8.85 / \text{ac}$$

Landgrading

Two levels of landgrading were considered in this example. The first level assumes that only the potholes are eliminated using the farmer's land plane at an estimated cost of \$75 per acre. This would be equivalent to providing poor to fair surface drainage. For the second case, a laser control land leveler is used at an estimated cost of \$125 per acre. This would be equivalent to providing fair to good surface drainage. Landgrading costs are normally amortized over 20 years, thus:

$$\text{annual amortized cost} = \$75/\text{ac} \times .13388 = \$10.04/\text{ac}$$

Operating costs for surface drainage generally include routine maintenance of the outlet ditches (moving and clean out), construction of hoe drains, and periodic smoothing of the field as it becomes uneven because of tillage. For an extensive surface drainage system (good surface drainage), maintenance costs average about \$8 per acre per year. These maintenance costs are closely correlated to the intensity of the surface drainage provided. As the cost of establishing the surface drainage increases, the cost of maintaining the same level of surface drainage also increases. For the purpose of comparing alternatives, it is reasonable to assume that maintenance costs for a surface drainage system costing \$125 per acre are about \$8 per acre per year, and adjust this value linearly as the initial cost of the system varies from \$125 per acre. Therefore, the operating costs for the fair surface drainage system (initial costs of \$75/ac) is assumed to be \$4.80 per acre per year.

Total system costs include fixed costs plus variable costs. Taking the subirrigation system with fair surface drainage, a drain spacing of 60 feet, and the deep well water supply as an example, the total annual system costs would be:

Fixed costs:	tubing @ 60 ft	\$54.08
	landgrading (fair)	10.04
	control structure	6.63
	water supply (well)	27.99
	Total annual fixed costs	\$98.74

Example 10-7 Economic evaluation—Continued

Variable costs:	repair and maintenance	
	tubing	\$1.08
	land grading	4.80
	control structure	neglected
	water supply	.70
	fuel (electric motor & pump)	\$8.85
	labor	\$2.30
	Total variable costs	\$17.73

Total annual system cost: **\$116.47**
(fixed costs + variable costs)

Thus, the annual amortized cost for this one system design with a drain spacing of 60 feet is \$116.47.

To compare the profit potential of several drain spacings, water table control settings, or management strategies, a DRAINMOD simulation must be ran for each case to be considered, then compute the cost. The optimum system design would then be determined by selecting the alternatives that provide the optimum profit. An example of this process is shown in table 10-5. This table compares profit with subirrigation for several drain spacings, levels of surface drainage, and water supplies. In this example, maximum profit for subirrigation occurs at a spacing of 50 feet for both fair and good surface drainage. The cost of the improved surface drainage cannot be recovered on this example site when good subsurface drainage is provided. As the level of subsurface drainage decreases, surface drainage becomes more important. However, proper modeling of irregular land surfaces would require simulations on the higher land elevations and low ponding areas to properly reflect surface storage, depth to water table, and yield variations within the field. This was not done because it was not found to be critical to the drain spacing. The additional costs of the well water supply, as compared to a surface supply, is also reflected in this example.

A detailed economic analysis and description is in the report by Evans, Skaggs, Snead, et al., Economic Feasibility of Controlled Drainage and Subirrigation (1986).

Example 10-7 Economic evaluation—Continued**Table 10-5** Predicted net return for subsurface drainage/subirrigation on poorly drained soil planted to continuous corn* (Evans, Skaggs, and Sneed, 1986)

Level of surface drainage	Drain spacing (ft)	Yield (predicted) (bu/ac)	Gross income (\$/ac)	System cost (\$/ac)	Production cost (\$/ac)	Total cost (\$/ac)	Net return (\$/ac)
Well Water Supply							
Fair	33	168.5	505.58	161.60	224.73	386.33	119.25
	50	162.9	488.78	127.49	224.73	352.22	136.56
	60	158.6	475.65	116.47	224.73	341.20	134.45
	75	152.1	456.23	105.44	224.73	330.17	126.06
	100	138.3	414.75	94.39	224.73	319.12	95.63
	150	108.3	324.98	83.37	224.73	308.10	16.88
	200	90.5	271.43	77.83	224.73	302.58	-31.15
	300	79.5	238.35	66.24	224.73	290.97	-52.62
Good	33	168.7	506.10	171.50	224.73	396.23	109.87
	50	163.3	489.83	137.39	224.73	362.12	127.71
	60	159.3	477.75	126.37	224.73	351.10	126.65
	75	154.5	463.58	115.34	224.73	340.07	123.51
	100	140.9	422.63	104.29	224.73	329.02	93.61
	150	118.3	354.90	93.27	224.73	318.00	36.90
	200	102.6	307.65	87.75	224.73	312.48	- 4.83
	300	91.5	274.58	76.92	224.73	301.65	-27.07
Surface Water Supply							
Fair	33	168.5	505.58	133.80	224.73	358.58	147.02
	50	162.9	488.78	99.72	224.73	324.45	164.33
	60	158.6	475.65	88.70	224.73	313.43	162.22
	75	152.1	456.23	77.67	224.73	302.40	153.83
	100	138.3	414.75	66.62	224.73	291.35	123.40
	150	108.3	324.78	55.60	224.73	280.33	44.65
	200	90.5	271.43	50.08	224.73	274.81	- 3.38
	300	79.5	238.35	39.25	224.73	263.98	-25.63

* Net return is to land and management based on \$3.00 per bushel for corn. Minimum management of the subirrigation system is assumed. Intensive management of the water management system could increase net return by up to an additional 10 percent. See text for more information.

624.1005 Designing water control structures

Many types of structures used to control water levels are manufactured. The manufacturer should furnish the hydraulic designs for their water control devices.

Flashboard structures, one of the most popular water control structures, for open ditch systems, are often used in open channels to control water levels, and flashboard stands are installed in sloping conduits used as drain outlets. To maintain a uniform water table, open stands with flashboards are installed in the line to control water elevations where the drop in the outlet exceeds a half foot.

Subsurface drains often outlet directly into ditches. As a result the ditches are used as a sump for delivering the irrigation water and as the main outlet for drainage. If subirrigation is to be efficient, the ditches must be controlled to prevent seepage losses. Flashboard risers have proven to be a desirable structure for controlling water levels in these systems.

Although many types of water control structures are used, this section will focus on design of flashboard risers and stands because they are the most prevalent.

(a) Flashboard riser design

Factors to consider in the design of flashboard risers:

- Crop to be grown influences the design removal rate of excess surface water.
- Elevation of the low area in the field influences the maximum high water level that can be tolerated during capacity flow.
- Elevation of the high area influences the low water level that can supply the needed moisture for evapotranspiration by upward movement of water (upflux).
- Interaction between the management intensity and the design capacity influences the design. Weir capacity can be decreased if the management intensity is increased. The recommended method is to size the weir to handle the design removal rate from normal rainfall events without removing flashboards.

A flashboard half round riser, with boards in place, is a pipe drop inlet (USDA, NRCS, EFH, chapters 6 and 13) and, with the flashboards removed, operates as a pipe or culvert. (**Caution: The riser is only one half of the pipe section and therefore, only has half the area of full round risers.**)

The equations governing flow in flashboard riser structures with boards in place (pipe drop inlet) are (USDA, EFH, chapter 3):

Weir flow:

$$Q = CLH^{\frac{3}{2}} \quad [10-36]$$

where:

- Q = weir capacity, ft³/s neglecting velocity of approach
- L = the length of weir, ft
- H = head on the weir, ft measured at a point no less than 4 H upstream from the weir
- C = 3.1 coefficient for weir flow

Orifice flow (both at barrel entrance and top of riser):

$$Q = 0.6A(2gH)^{\frac{1}{2}} \quad [10-37]$$

where:

- Q = orifice capacity, ft³/s
- A = area of the orifice opening, ft²
- g = 32.2 ft/s²
- H = hydraulic head over the center of the orifice, ft

Pipe flow (full barrel) Assume outlet submerged:

$$Q = A \left[\frac{(2gH)}{(1.0 + K_e + K_p L)} \right]^{\frac{1}{2}} \quad [10-38]$$

where:

- Q = pipe capacity, ft³/s
- A = cross sectional area of the pipe, ft²
- H = hydraulic head, ft
- g = 32.2 ft/s²
- K_p = friction loss coefficient
- K_e = entrance loss coefficient (usually 1.0)
- L = length of pipe, ft

Two major types of culvert flow are flow with inlet control and flow with outlet control. Different factors and formulas are used to compute the capacity of each type culvert. The diameter of barrel, inlet shape, and the height of headwater or ponding at the entrance determine the capacity under inlet control. Outlet control involves the additional considerations of the elevation difference between headwater and tailwater in outlet channel and the length of culvert (barrel). The NRCS, EFH, Chapter 3, Hydraulics, describes culvert flow and K_p and K_e values in more detail.

Guidelines for the design of flashboard risers include:

- Design discharge pipe with adequate surcharge (orifice flow or H_w/D) for full pipe flow. This is the most critical condition in open ditches when flashboards are removed.
- Keep the design head on the structure at 0.5 foot or less. A higher design head can cause the normal water level to be too low to provide adequate irrigation, or adjacent land may be flooded at design flow. Design head on barrel should be 0.3 foot or less if the drainage channels were not designed from detailed topographic information.
- Size the riser to carry the design removal rate without removing any flashboards, when practical. In ditches, the riser diameter is designed to pass the surface water removal rate (drainage capacity) below the lowest elevation in the field either over the flashboards or over both the flashboards in place and the top of the riser.
- The height of the riser in a ditch should protect the lowest elevation in the field. (See the previous paragraph.)
- The length of individual flashboards should not exceed 4 feet. Longer boards tend to deflect and leak and are extremely difficult to remove.
- The length of barrel should be a minimum of 20 feet unless special measures are used to prevent seepage and piping.

624.1006 Management

The land manager must be knowledgeable of the principles of water table control (subsurface drainage and subirrigation) to operate the system successfully. Many problems associated with poor performances of water table control stem from improper management. The key component in the management is to develop an observation system and evaluation procedure that demonstrate how the system is performing.

(a) Computer aided management

Selecting the proper water table control elevation and timing of the subirrigation and drainage phases are part of the management of a system. Manual adjustment of the control devices are often not accomplished in a timely manner because of conflicting schedules. Recent research developments have enabled linking current weather forecast data to the control structures through computers, modems, and telephone lines. This approach allows selection or adjustment of the water table elevation in the field from a remote location based on current weather forecast data, probability of rainfall occurrence, and system characteristics. The economic feasibility for such a system should be evaluated before site specific use is implemented.

The land manager needs to be guided through at least one phase of drainage and subirrigation using a field observation system. During this period the theory should be explained using simple sketches to illustrate the observed water table fluctuations occurring in response to management.

(b) Record keeping

Another facet of management that has helped many managers understand the performance of the system is record keeping. Land managers who keep accurate records of rainfall, observation well readings, the amount of irrigation water used, and yields are generally efficient managers. These records provide a means for diagnosing performance problems. For example, if the yield does not meet expectations at the end of the year,

conclusions can be drawn based on the water table elevations during critical periods of crop development.

(c) Observation wells

Observation wells must be used if a subirrigation or controlled drainage system is to be managed efficiently. The system cannot be properly managed by merely observing the level of water in the ditch or outlet and holding the water level at a constant elevation throughout the season. This inefficient method of management results in higher energy cost, waste of irrigation water, and in some cases a reduction in yield.

Observation wells should be located midway between the drains or ditches (fig. 10-54). Most landowners prefer that the wells be located in the center of the row, and as a result, usually install the wells immediately after planting.

Observation wells can be made of any type of material; however, PVC is the most common material used because of its cost, weight, and availability. The water level in the well must fluctuate simultaneously with

the water table in the field. To assure that entry of water into the well is not the limiting factor, approximately 20 holes should be bored in each well. The diameter of each hole depends upon the amount of fine sand and silt in the soil. Generally holes 3/16 inch in diameter or smaller will suffice.

The most popular size observation well has been 4 inches in diameter and 4.5 to 5.0 feet deep. The well should be sized so that the depth to the water table can be accurately determined. The diameter of the observation well is not important except in fine textured soils that have low drainable porosity. In these soils, fluctuations of the water level in the well lag behind fluctuations in the field by several hours, suggesting a smaller diameter well should be used.

A device is needed to measure the level of the water in the observation well. The device can be electrical, mechanical, or manual. The most popular device has been a float constructed from a plastic or glass bottle with a dowel rod stuck through the cap. The dowel rod is usually calibrated in half-foot intervals. Plastic pipe capped on both ends works well in observation wells 2 to 4 inches in diameter.

Figure 10-54 Locating observation wells, and construction of the most popular type of well and float

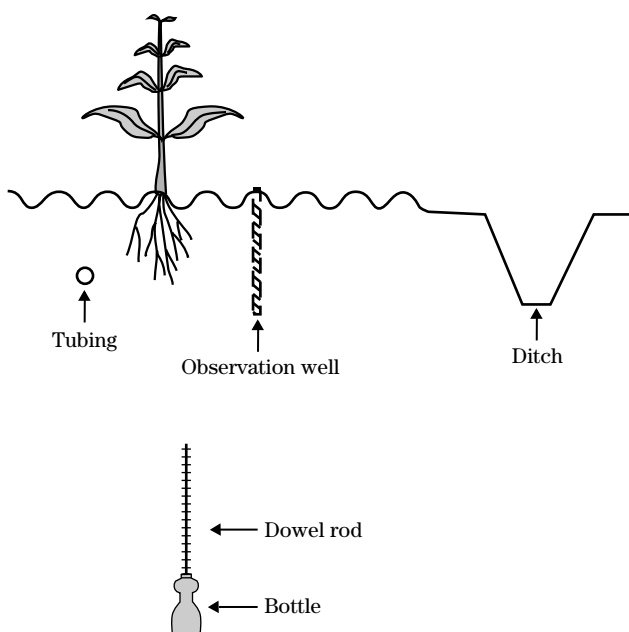

Location: Place in center of row midway between drains or ditches.

Installation: Bore hole slightly larger than observation well casing. Slide well casing into the hole. Allow the well to protrude 3 to 5 inches above the row to prevent covering and filling with earth during cultivation. The well should be installed as deep as the ditches, drains or barriers. A well depth of 5 feet is desirable for normal fluctuating water tables.

Construction: 4-inch PVC conduit is the most common material used; however, other material may suffice.

Float construction: Plastic or glass bottles are the most common material used with dowel rods inserted through an opening in the cap. Capped plastic pipe generally calibrated in half foot intervals, works as a float and rod.

(d) Calibration

A water table control system needs to be calibrated and fine-tuned during the first year of operation. Although the design is based on proven theory, it is only as accurate as the input data used. Many times obtaining accurate input data is difficult, making assumptions based on experience necessary. In most cases a design based on theory and tempered with conservative assumptions is adequate, but the elevations for drainage and subirrigation must be adjusted by experience (fine-tuned) to control water table at peak efficiency.

To calibrate a subirrigation or controlled drainage system, the ground elevation of the zone requiring the highest degree of management (strategic area) should be marked on the water control structure at its outlet. A manager can observe and understand the relationships that exist between the water level in the outlet and the water table in the field during drainage and subirrigation.

A scale placed in the ditch close to the observation well is helpful where a parallel ditch system or a sub-surface system that empties into a ditch is to be calibrated. The scale should have the ground elevation of the strategic areas marked. Marking a scale in the ditch close to the observation well and marking the outlet structure allow the land manager to quickly reference the water level in the ditch to that in the field (fig. 10-56). A closed system of tubing needs a scale installed in a stand (riser) the same as for ditches, but in some cases only one outlet structure can be marked (fig. 10-57).

Figure 10-56 Observation and calibration methods for **open** systems, parallel ditches or tile systems which outlet directly into ditches

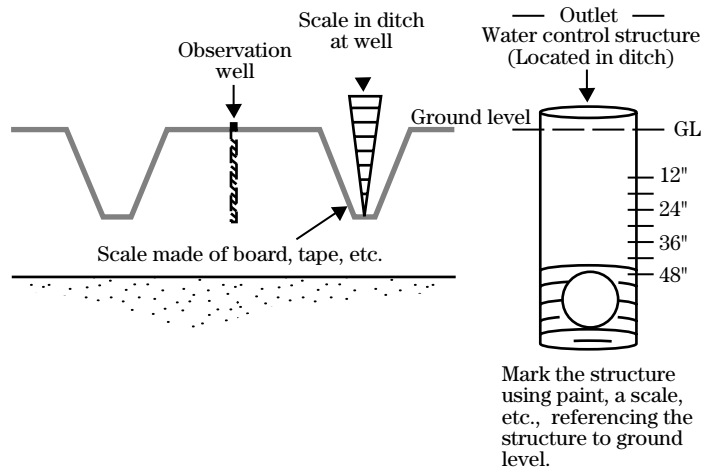
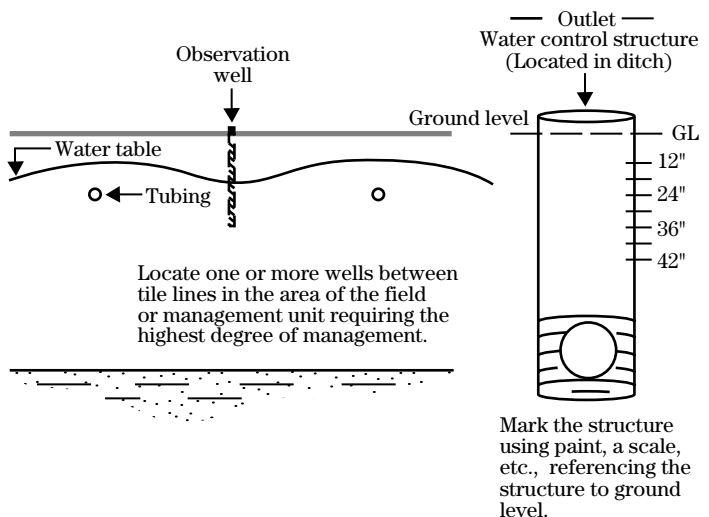

Figure 10-57 Observation and calibration systems for **closed** drain systems



(e) Influence of weather conditions

Weather conditions normally dictate how the water table is managed. The amount of rainfall determines whether the system should be in the drainage or subirrigation mode.

Figure 10–58 illustrates the influence of weather conditions on water table during subirrigation. Curve 2 shows the optimum water level to be maintained during steady state conditions. The water table is initially raised to this level by pumping or rainfall. If the 3 to 5 day forecast is for dry weather, the water table should be raised to level 1 at which point it will be allowed to recede to level 2. This is not necessary when adequate water and management are available to maintain the optimum level daily. If the forecast at this time calls for rain, the level is allowed to drop to level 3. This helps provide for maximum soil storage of the rainfall. If no rain has occurred by the time the water table reaches level 3, the water table should be raised by pumping. When level 2 is reached, a decision to continue or stop pumping will be made based on the forecast at the time. In any case the water level needs to be raised to the optimum level on a frequent interval (3 to 5 days) to provide a stable root environment for the crop.

Figure 10–58 Water table control during subirrigation

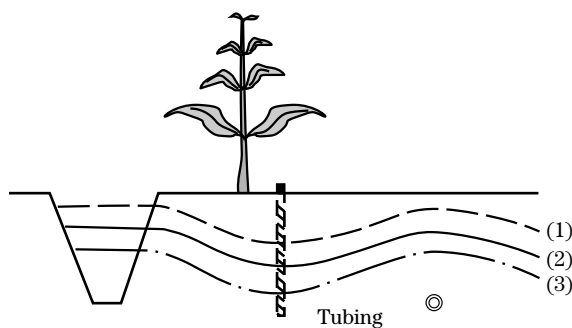

- Curve # 1: The highest level that the water can be pumped or stored after rainfall without damaging the crop.
- # 2: The optimum water table level. Generally, the water table is allowed to fluctuate 6 inches above (curve # 1) or below (curve # 3) this level.
- # 3: The lowest tolerable level, and at this level ET demands may not be totally satisfied.

Figure 10–59 illustrates the influence of weather conditions on controlled drainage systems. If no rain is forecast the drainage is stopped at level A and allowed to recede to level B by ET and seepage. However, if rainfall is predicted, drainage is stopped between level A and level B, depending on available drainage rate.

The previous discussion has shown that while the system is normally designed assuming a steady state condition or a minimum amount of management flexibility, the system cannot be managed efficiently as a steady state system. Therefore, a management plan or strategy must be developed. The objective of the plan is to provide the landowner with guidelines for daily management decisions. The daily management decisions vary from site to site, and the management plan must consider the soil, crop, and system design capabilities for each site. Figure 10–60 illustrates a sample water table management plan.

Figure 10–59 Water table control during drainage

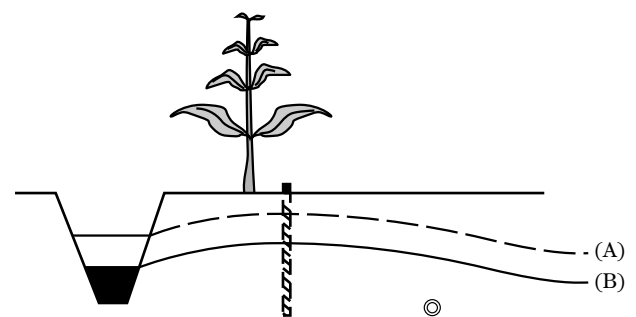

- Curve A: The highest level that the water can be stored immediately after rainfall, approximately 12 to 15 inches below the ground surface.
- Curve B: The optimum level to meet ET demands and still provide adequate drainage, generally ranging from 21 to 30 inches below the ground surface.

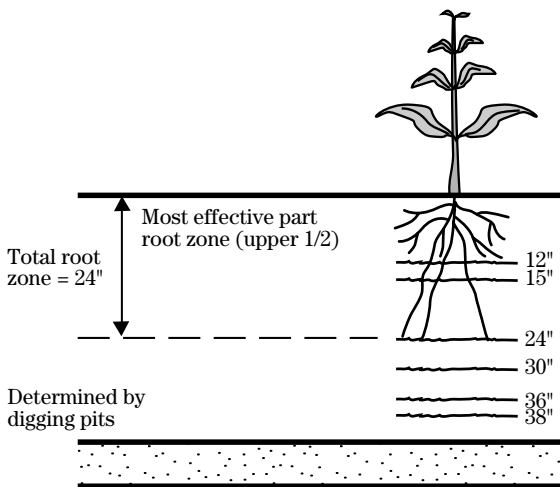
Figure 10-60 Sample water table management plan

12 inches—The upper 12 inches of the root zone accounts for about 70 percent of the nutrient and water uptake, thus, will be a reference during irrigation and drainage.

15 inches—The drainage process stops when the water table reaches 15 inches. The water table is controlled at this level throughout the winter to improve water quality.

30 inches—When irrigating, the water table will not be pumped higher than 30 inches, which will supply 0.25 inch of water per day to the root zone. During critical stages of crop growth, the water table is maintained at this level.

36 inches—The water table is controlled at this point during planting and harvest operation. Experience has shown that an adequate rate of drainage can be achieved at this elevation.

38 inches—During irrigation, the water table is not allowed to fall below this level. At this level, it only supplies about 0.09 inch of water per day to the root zone. To raise the water table to 30 inches takes 3 days (based on experience and calculations). Thus, when the crop is not in critical state, and when weather patterns look promising, the water table is allowed to fall to this level.

Note: *All management levels are for the midpoint between ditches or tubing.*

624.1007 Water quality considerations of water table control

Agricultural areas having a natural or induced high water table are frequently affected by periods of high rainfall, occasional flooding, and seasonal drought. These and other factors contribute to the complex mechanisms that govern the water quality impacts of water table control systems.

Extensive research has documented many environmental effects of improved drainage in sensitive areas. Water table control can minimize the negative environmental impacts of drainage, improve water quality, enhance wetlands, and improve potential for agricultural production. Water table control systems, when properly designed and managed, can accomplish such water quality and production objectives as flood control, wetland enhancement, sediment loss reduction, water conservation, and water quality protection. Water table control systems generally incorporate drainage, controlled drainage, and subirrigation in one sophisticated system. This allows the manager to optimize soil-water conditions for crop growth and improvement of water quality.

(a) Water quality impacts

Depending upon the management practices followed in the operation of a water table control system, water quality impacts may include the following:

- Water table control to maintain relatively high field water table levels tends to increase the proportion of surface runoff in total outflow. This normally results in higher concentrations of phosphorus and sediment in the outflow than would otherwise occur with uncontrolled drainage. The higher water table levels tend to increase the potential for denitrification and should result in lower concentrations of nitrate-nitrogen in the outflow as compared to uncontrolled drainage.
- One of the most frequently observed impacts of water table control is its influence on total nutrient transport in drainage outflow. By reducing outflow volume, drainage control normally

reduces the annual transport of total nitrogen and total phosphorous to surface streams and estuaries. The reduction is nearly proportional to the reduction in total outflow.

- Subsurface drainage systems tend to reduce peak flows from fields as compared to surface drainage systems on similar soils.
- Systems that emphasize subsurface drainage rather than surface drainage generally have less surface runoff and thus less loss of sediment and adsorbed constituents, such as phosphorus and some pesticides. However, these systems may contain higher concentrations of nitrates.
- Depending on the control strategy, water table control may increase outflow rates during wet periods because the water table elevation at the beginning of rainfall events is higher than that where conventional drainage is used.

(b) Management guidelines for water quality protection

Management of water table control systems is very much a function of soil type, crop, and downstream environmental conditions. The following guidelines generally apply to systems used for row crop production on mineral soils. Systems used for production of speciality crops, or crops grown on deep sandy or organic soils will almost always require special management considerations.

Operation of water table control systems includes two important management considerations:

- optimum production efficiency
- maximum water quality benefits

In most cases the objective is to maintain an acceptable balance between the two depending upon specific site and downstream environmental conditions.

To obtain the potential benefits of water table control, both for production and water quality, requires a relatively high level of management. In most cases water table control is accomplished by operating a system of outlet control structures, water supply pumps for subirrigation, and, if needed, drainage pumps to maintain the water table at a fixed level for defined periods. Because site conditions change over time, management decisions must be made and carried out in a timely way to obtain the correct operating mode.

The water quality of downstream receiving water should be considered in selecting a management strategy. Where the system discharges into a freshwater river or stream, the primary concern normally is eutrophication. The management goal in this case should be to reduce the concentration of N and P in the drainage water. If the system discharges into a marine estuary the primary concern may be to reduce freshwater inflow by reducing peak drainage outflow rates.

(1) Selecting the best water table depth

What is the optimum depth to control the water table?

This is the most frequently asked question by beginning water table control system operators and the most difficult to answer. In humid areas the control depth may fluctuate several inches from day to day in response to rainfall, ET, drainage, or other conditions.

Experience has shown that optimum yields may be obtained for many crops through a wide range of water table depths (12 to 60 inches) depending on soil type, profile layers and their hydraulic properties, weather conditions, the crop being grown, crop development, and rooting depth. Most crops can tolerate a fluctuation in the water table of 6 inches without any adverse effects. Also, yield reductions do not occur on most soils from short-term fluctuation (durations of up to 24 hours) in the water table if the water table depth is not less than 12 inches during wet periods or more than 40 inches during dry periods.

(2) Holding water table elevations high to reduce outflow

Total drainage outflow generally decreases (to near pre-drainage levels) as the control elevation is raised to the soil surface. Minimizing outflow minimizes the potential transport of fertilizer nutrients. Holding the water table level high during the growing season increases the potential loss of nitrogen by denitrification, thus reducing the nitrate levels in the drainage water. However, this strategy increases the potential for transport of phosphorus as a result of increasing the proportion of surface runoff.

Obviously, this strategy would not be the most desirable from a production standpoint because a shallow field water table elevation restricts root growth, plant evapotranspiration, and nutrient uptake with a corre-

sponding loss of production and increase in nutrient losses into drainage water. This strategy to hold water levels high is beneficial for water quality during the nongrowing season, but it reduces yields if followed during the growing season.

(3) Lower water table to provide soil trafficability

Lowering the water table to provide soil trafficability in a timely manner for tillage, planting, and harvesting operations also benefits crop production and water quality. Where tillage or harvest operations are carried out on wet soils, serious trafficability problems result in the destruction of soil structure. This leads to reduced infiltration, increased surface runoff, and reduced root growth and ET during drier periods. The water table should be lowered at least 2 days before planned tillage or harvest operations. Experience has shown good results when the water table is lowered from 24 to 40 inches below the soil surface before tillage.

(c) Management guidelines for production

The following basic operating guidelines for water table control assume the objective is for efficient production without special water quality constraints.

- Before spring tillage and seeding operations begin, the water table control system should be operated in a free drainage mode. The water table should be about 40 inches below the soil surface or at a depth sufficient to ensure trafficability. Immediately following tillage and planting, the water table control devices should be set and irrigation water provided as needed to bring the water table high enough for capillary action to moisten the seedbed soil. The water table should then be dropped to the normal growing season depth for seed germination and early plant root development.
- Throughout the growing season the irrigation water supply and water level control devices should be operated to maintain the water table at selected depth for the soil type and crop grown.
- During a rainfall event the irrigation supply should be shut off and if the water table rises significantly, the system should be put in a drainage mode until the water table again reaches the selected depth.

- When the crop reaches maturity, the water table should be lowered to provide soil trafficability for harvest operations.
- Following harvest the system should be operated in the free drainage mode throughout the winter.

(d) Example guidelines

Table 10–6 summarizes water table control guidelines for a 2-year rotation of corn, soybeans, and wheat in a humid area. These guidelines are recommended to improve production and drainage water quality. Without this level of management, neither objective will be realized. The control settings shown in table 10–8 are the weir elevation of the control structure relative to average soil surface elevations and are the target average field water table elevations. Actual water table levels in the field may be different from the weir elevation depending on whether the system is in a drainage or subirrigation cycle.

(e) Special considerations

When the management objective is to optimize production, operation of the water table control system is primarily carried out during the growing and harvest season. In contrast, to optimize water quality benefits, the system must also be operated during the non-growing season. Obviously, year-round operation of a system can help achieve both objectives. As seen in table 10–6, most control elevation adjustments are related to providing trafficability and adjusting the water table in response to seasonal fluctuations in rainfall. More intensive management may be needed during special circumstances. For example, during a wet period early in the growing season (March to May in this example), the weir elevation should be about a foot lower than the values shown to improve trafficability, increase potential storage for infiltration, and reduce the potential for surface runoff, phosphorus transport, and higher peak outflow rates.

Intensive summer thunderstorms sometimes exceed the infiltration rate of the soil resulting in a loss of much needed water by surface runoff. To retain this water onsite, the weir elevation can be raised to temporarily retain this water in the field ditches where it

will then move back into the field by subsurface flow. However, if the water level in the field ditches has not receded to at least 1 foot within 24 hours, the weir elevation should be lowered to the suggested levels shown in table 10–6. Weirs in the outlet ditch should not be raised above 18 inches and left unattended for more than 24 hours during the growing season because serious crop damage may result if excessive rainfall occurs. Whenever weir adjustments are needed to remove excess water, the weir should not be lowered more than 6 inches within a 3-hour period if the system contains open ditches. When the water level in the outlet ditches is high, the ditchbanks are saturated and often unstable. Lowering the water level too quickly may result in ditchbank sloughing and erosion. Also lowering the weir in small increments minimizes peak outflow rates.

Another example of when more intensive management than that shown in table 10–6 might be required is when the management strategy is to reduce peak outflow rates. Water table management systems function primarily in the drainage cycle during seasonal periods when field water table elevations are high and rainfall exceeds ET. Peak outflow rates generally are higher during this period as a result of the higher field water table elevations resulting from controlled drainage. To reduce peak outflow rates, surface runoff must be reduced and maximum potential soil storage provided between rainfall events. To minimize surface runoff, the weir elevation should be set at or near the soil surface when rainfall is anticipated or forecast. After the rainfall event and as soon as all surface water has infiltrated, the weir elevation should be lowered incrementally once a day to its lowest possible elevation or until the next rainfall event occurs. This allows the soil profile to drain gradually, but uniformly, and also provides the maximum potential soil storage for the next rainfall event. This intensive management would be necessary from late in February to May for this example. During the rest of the year, management would proceed as outlined in table 10–6.

The reduction in peak outflow rates that could be achieved using this strategy is substantial. The major disadvantage could be an increase of total drainage outflow with a resulting greater transport of nutrients to the discharge water. Thus this strategy is useful only for the special case of a system discharging into coastal water sensitive to salinity fluctuations.

Table 10-6 Water table management guidelines to promote water quality for a 2-year rotation of corn-wheat-soybeans ^{1/}

Period	Production activity	Control setting ^{2/} (in)	Comments ^{3/}
Mar 15 - Apr 15	Tillage, seedbed preparation, planting	40	Just deep enough to provide trafficability and good conditions for seedbed preparation
Apr 15 - May 15	Crop establishment early growth	24 - 30	Deep enough to promote good root development
	Nitrogen sidedress	20 - 40	Just low enough to allow trafficability
May 15 - Aug 15	Crop development & maturity	20 - 24	Temporary adjustment during wet periods
Aug 15 - Oct 15	Harvesting, tillage, plant wheat	30 - 40	Low enough to provide trafficability
Oct 15 - Mar 1	Wheat establishment	24	Lower during extremely wet periods
Mar 1 - Mar 15	Sidedress wheat	24 - 40	Low enough to provide trafficability
Mar 15 - Jun 15	Wheat development & maturity	20 - 24	Temporary adjustment during wet periods
Jun 15 - Jul 15	Harvest wheat tillage, plant beans	30 - 40	Depends on season
Jul 15 - Nov 1	Soybean development & maturity	20 - 24	Temporary adjustment to allow cultivation
Nov 1 - Dec 15	Soybean harvest	40 - 50	Low enough to provide trafficability
Dec 15 - Mar 15	Fallow	12 - 18	

1/ Managing water table management systems for water quality ASAE/CSAE paper 89-2129, R.O. Evans, J.W. Gilliam, and R.W. Skaggs.

2/ Values shown are the control setting and should not be considered the actual water table depth in the field, which will actually be lower except during drainage periods.

3/ Most adjustments are related to trafficability and must take into account weather conditions and soil-water status at the time. In an unusually dry season, control can be 3 to 6 inches higher. In an unusually wet season, control can be 3 to 6 inches lower. In coarse texture soil, trafficability can be provided with the water table about 6 inches higher.

624.1008 References

- Alberts, R.R., E.H. Stewart, and J.S. Rogers. 1971. Ground water recession in modified profiles of Florida Flatwood soils. *Soil and Crop Science Soc. FL Proceed.* 31:216-217.
- Allmaras, R.R., A.L. Black, and R.W. Rickman. 1973. Tillage, soil environment and root growth. *Proc., Natl. Conserv. Tillage Conf., Des Moines, IA*, pp. 62-86.
- Anat, A., H.R. Duke, and A.T. Corey. Steady upward flow from water tables. *Hydrol. Pap. No. 7.* CO State Univ., Fort Collins, CO.
- Baver, L.D., W.H. Gardner, and W.R. Gardner. 1972. *Soil Physics*, 4 ed., John Wiley & Sons, NY.
- Blaney, H.F., and W.D. Criddle. 1947. A method of estimating water requirements in irrigated areas from climatological data. *USDA Soil Conserv. Serv. report (rev.)*.
- Bloodworth, M.E., C.A. Burlison, and W.R. Cowley. 1958. Root distribution of some irrigated crops using undisturbed soil cores. *Agron. J.*, vol. 50:317-320.
- Boast, C.W. and Don Kirkham. 1971. Auger hole seepage theory. *Soil Sci. Soc. Am. Proc.* 35:365-374.
- Bouwer, H. 1963. Theoretical effect of unequal water levels on the infiltration rate determined with buffered cylindrical infiltrometers. *J. Hydrol.* 1:29-34.
- Bouwer, H. 1964. Measuring horizontal and vertical hydraulic conductivity of soil with the double-tube method. *Soil Sci. Soc. Am. Proc.* 28:19-23.
- Bouwer, H. 1966. Rapid field measurement of air-entry value and hydraulic conductivity of soil as significant parameters in flow system analysis. *Water Resource. Res.* 2:729-738.
- Bouwer, H. 1969. Infiltration of water into nonuniform soil. *J. Irrigation and Drainage Division, Amer. Soc. Agric. Eng.* 95(IR4):451-462.
- Bouwer, H. 1974. Developing drainage design criteria. *In Drainage for Agriculture*, ch. 5, J. van Schilf-gaarde, ed., Amer. Soc. of Agron., Madison, WI.
- Bouwer, H., and J. van Schilf-gaarde. 1963. Simplified method of predicting the fall of water table in drained land. *Amer. Soc. Agric. Eng.* 6(4):288-291, 295.
- Bouwer, H., and R. D. Jackson. 1974. Determining soil properties. *In Drainage for Agriculture*, J. van Schilf-gaarde (ed.), Amer. Soc. of Agron., Madison, WI, pp. 611-672.
- Brakensiek, D.L. 1977. Estimating the effective capillary pressure in the Green-Ampt infiltration equation. *Water Resource. Res.* 13(3):680-682.
- Ernst, L.F. 1950. A new formula for the calculation of the permeability factor with the auger hole method. *Agricultural Experiment Station T.N.O. Gronengen, the Netherlands.*
- Evans, R.O., J.W. Gilliam, and R.W. Skaggs. 1989. Managing water table management systems for water quality. *ASAE/CSAE paper 89-2339.*
- Evans, R.O., R.W. Skaggs and R.E. Sneed. 1986. Economic feasibility of controlled drainage and subirrigation. *NC Agric. Coop. Ext. Serv. AG397.*
- Fouss, J.L. 1985. Simulated feedback—Operation of controlled drainage/subirrigation systems. *Amer. Soc. Agric. Eng.* 28(3):839-847.
- Fouss, J.L., and J.R. Cooper. 1988. Weather forecasts as control input for water table management in coastal areas. *Amer. Soc. Agric. Eng.* 81(1):161-167.
- Hall, H.W. 1976. Reservoir water losses as affected by groundwater mounds. *ASAE pap.* 76-2021. Presented at the 1976 annual ASAE meeting, Lincoln, NE.
- Skaggs, R.W. 1979. Water movement factors important to design and operation of subirrigation systems. *ASAE pap.* 79-2543, Amer. Soc. Agric. Eng., St. Joseph, MI.

-
- Skaggs, R.W. 1980. DRAINMOD reference report. Method for design and evaluation of drainage - water management systems for soil with high water tables. Rep. USDA, Soil Conserv. Serv., ch. 5 and pref.
- Skaggs, R.W., and Nassehzadeh-Tabrizi. 1986. Design drainage rates for estimating optimum drain spacing. Trans. Amer. Soc. Agric. Eng., Vol. 29(6):1631-1640.
- Skaggs, R.W., Nassehzadeh-Tabrizi, and R.O. Evans. 1985. Simplified methods for determining subirrigation drain spacings. Amer. Soc. Agric. Eng. pap. no. 85-2054. St. Joseph, MI.
- United States Department of Agriculture, Soil Conservation Service. 1971. Drainage of agriculture land. Natl. Eng. Handb., sec. 16, pp. 4-43.
- United States Department of Agriculture, Natural Resources Conservation Service. Eng. Field Handb. (EFH).
- United States Department of Agriculture, Natural Resources Conservation Service. Hydrology tools for wetland determination workbook. National Employee Development Center. p227.
- United States Department of Agriculture, Natural Resources Conservation Service. National Handbook of conservation practices. Practice Standard 606, Subsurface Drain.
- van Bavel, C.H.M. and Don Kirkham. 1948. Field measurement of soil permeability using auger holes. Soil Science Society of America Proceedings, vol. 13, pp. 90-96.